

FineFIRE

Quick Start Guide

1. Installation – Launching
2. CAD Component
3. Calculation Environment

Preface

FINE FIRE, the **F**ully **I**ntegrated **E**nvironment for **Fire Fighting** Installations performs all necessary hydraulic calculations and can handle tree, loop and grid sprinkler systems. It calculates automatically pipe diameters and friction losses, finds the most unfavourable and favourable areas of the network and selects the fire pump with the Hydraulic solution method.

This Quick Start Guide provides a fast and friendly introduction on FINE FIRE main features and functionalities. In conjunction with this guide, you can find helpful step-by-step videos in www.4msa.com. All the features and functions of the program are presented and explained in detail within the complete User's Guide, along with informative examples.

FINE FIRE combines both designing and calculations in a uniform, integrated environment, consisting of two main components, CAD and Calculations:

- Concerning the **CAD component**, it is based on an autonomous CAD embedding 4MCAD engine adopting the common cad functionality and open dwg drawing file format. The CAD component helps the user to design and then calculate and produce completely automatically the entire calculations issue for every Fire fighting project, as well as all the drawings in their final form.
- Concerning the **Calculations component** (called also as ADAPT/FCALC), it has been designed according to the latest technological standards and stands out for its unique user - friendliness, its methodological thoroughness of calculations and its in-depth presentation of the results. The FIRE Calculation module acquires data directly from the drawings (automatically), thus resulting in significant time saving and maximum reliability of the project results. It can also be used independently, by typing data within the calculation module spreadsheets.

Despite its numerous capabilities, FINE FIRE has been designed in order to be easy to learn. Indeed, the simplicity in the operation philosophy is realized very soon and all that the user has to do is to familiarize himself with the package.

This Guide is divided into 3 short parts:

- Part 1 describes the installation procedure and the main menu structure.
- Part 2 deals with the CAD component of FINE FIRE, showing its philosophy and main features.
- Part 3 describes the calculation environment of FINE FIRE.

<i>FineFIRE</i>	<i>i</i>
<i>Preface</i>	<i>ii</i>
1. Installation - Launching	1
1.1 Installing FineFIRE	1
2. CAD Component	3
2.1 Overview	3
2.2 Main menu	4
2.3 Drawing Principles & Basic Commands	5
2.3.1 Drawing aids	6
2.3.2 Drawing Coordinates	7
2.3.3 Drawing Basic Entities	7
2.3.4 Useful Commands	8
2.3.5 Grips	9
2.3.6 Print	9
2.3.7 Plus Drawing Tools	10
2.4 AutoBUILD: Architectural Drawing	11
2.4.1 Building Definition	12
2.4.2 Drawing Walls	13
2.4.3 Drawing Openings	14
2.4.4 Other Entities	14
2.5 AutoNET: Network Drawing Principles	15
2.6 AutoNET: FineFIRE Installation	21
3. Calculations	29
3.1 Introduction	29
3.2 Main Menu	32
3.3 Files	33
3.4 Project Data	34
3.5 Draw Vertical Diagram	35
3.5.1 Vertical Diagram Creation	35
3.5.2 Update from vertical diagram	38
3.6 View	38
3.7 Windows	38
3.7.1 Cover Page	38
3.7.2 Assumptions	39
3.7.3 Systems of Receptors	39
3.7.4 Receptors Legend	39
3.7.5 Calculation Sheet	39
3.7.6 Fire Pump Calculation	43
3.7.7 Water Tank Calculation	44
3.7.8 Network Drawing	44
3.7.9 Vertical diagram	44
3.7.10 Sections Friction drop	45
3.7.11 Network checking	45
3.7.12 Four sprinklers under consideration	45
3.7.13 Bill of Materials - Costing	45
3.7.14 Detailed Bill of Materials	45

3.7.15 Technical Description.....	45
3.8 Libraries.....	46
3.9 Help.....	46
3.10 Examples.....	46
3.10.1. Building design example.....	48
3.10.2. Fire fighting Network design example.....	52

1. Installation - Launching

1.1 Installing FineFIRE

1. Insert the CD in your computer CD-ROM drive (e.g. D:, E:) or, if you received your software via Internet, run the installation application you downloaded.
2. When the Welcome window appears (as shown below), click **Next**.



3. When the License Agreement appears, read it carefully. If you agree with the terms, check the respective button and then click **Next** (you must agree with the terms to proceed with the installation).
4. In the next screen enter your username and organization information and check if you want to create a desktop icon. Then click **Next** to see if the information is correct (see the following window) and finally click **Install** for the installation procedure to begin.
5. Upon completion of the installation procedure, the following last window appears on screen and all needed is to click **Finish**. In case that the **Run FINE 14NG** checkbox is selected, the program will start running.



6. After the installation, you can find the program within the programs list.

2. CAD Component

2.1 Overview

FineFIRE is the powerful Workstation for Fire Fighting installation design that automatically performs the necessary calculations directly from the drawings, producing all the Project results (Calculation issue, technical descriptions, full-scale drawings, Bills of materials etc.). FineFIRE automates the designing process providing the user with the appropriate installation designing solutions.

This first Part of the user's guide (Part I) describes the operation of the CAD component of FineFIRE. As mentioned in the preface, the CAD component is based on 4MCAD technology.

Regarding technical aspects, it should be mentioned that the package follows a completely object oriented philosophy (OOP). This practically means that the package considers the building and the FIRE installations as logical entities which consist of individual objects clearly related to each other and with accurately defined characteristics. These intelligently structured "information" of the building and its fire fighting installations combined with the advanced technology (C++) that was utilized for its development, provide the package with an experienced behavior, resulting in an Intelligent Workstation, that is an invaluable helping hand to every Designer.

FineFIRE CAD Component includes two main modules, which co-operate closely and give the designer the impression that he virtually works on the building: It is about a) the AutoBUILD (or AutoBLD) that is used to load-identify the building and b) the AutoNET that is used to design and identify the network installations. Those two subsystems are supported by a third one, with the name PLUS, which includes many useful designing facilities.

2.2 Main menu

As soon as the program is loaded, the main menu screen appears for the first time:

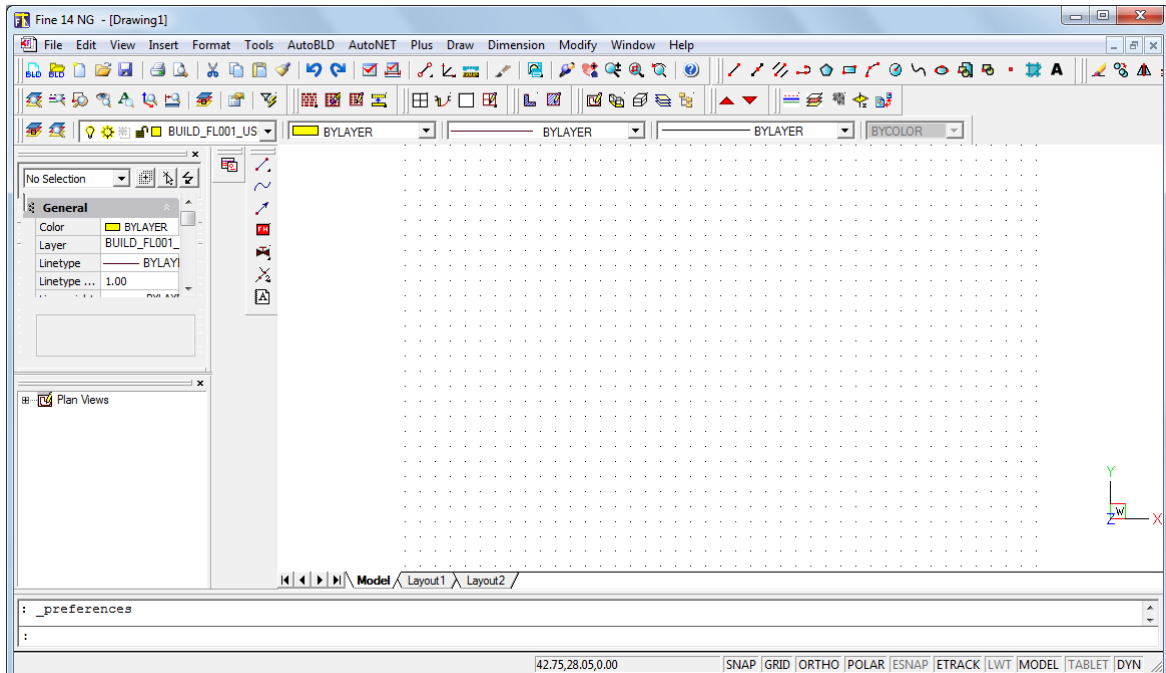

Among the commands of the designing environment, we notice the following main options of the package:

1. Project files management options (New Project, Open Project and Project Information) which are located into the options group **FILE**.
2. Option Group with the name **AutoBLD**, which includes all the commands required for the Architectural designing.
3. Option group with the name **AutoNET**, which includes all the commands required for the designing and calculation of the application.
4. Auxiliary option group with the name **PLUS**, which contains a series of designing facilities for the user.

Starting with FINE, you define a new project through the corresponding option in the FILE menu mentioned above. In case that "New project" is selected, a window appears on the screen where the name of the Project should be typed.

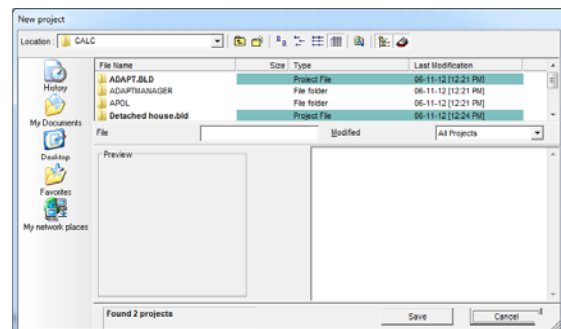

In order to "load" an existing project, which has been created with the program and you want to further edit it or just view it, you select "Select Project", and a list with the existing projects in the hard drive will be displayed on the screen. At first, the list displays all the projects that exist in the FINE directory and with the use of the mouse or the keyboard and acting correspondingly, you can transfer to any other directory, viewing at the same time the existing projects. It is noted that the projects are included into directories with the extension BLD. If an existing project is selected, it is loaded and displayed on the screen.

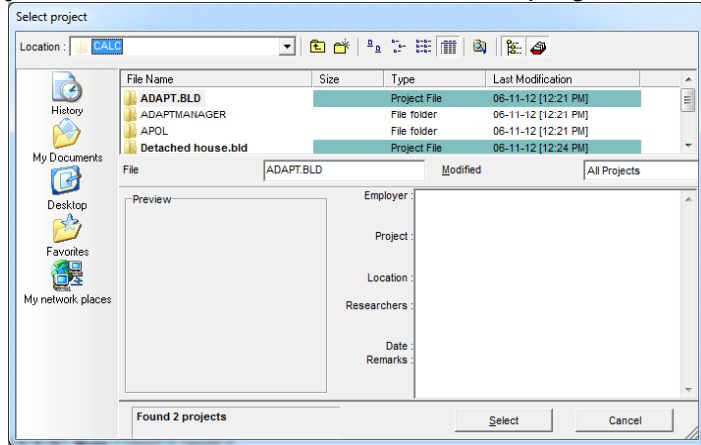

Either if a new project is created or a saved one is loaded, you can start working with the use of the subsystem commands described above. A detailed description of these commands is available in the following chapters. Before this detailed description, a short reference of the basic designing principles featured in the designing environment of the package is recommended, in chapter 2.3 that follows next. If you are familiar with the use of 4MCAD or AutoCAD, you may page through or even skip this chapter, while if you are not, you should read it carefully.

2.3 Drawing Principles & Basic Commands

A great advantage of the package is that the structure and the features of the drawing environment follow the standards of the CAD industry adopted by AutoCAD, 4MCAD etc. In particular, the available working space is as follows:

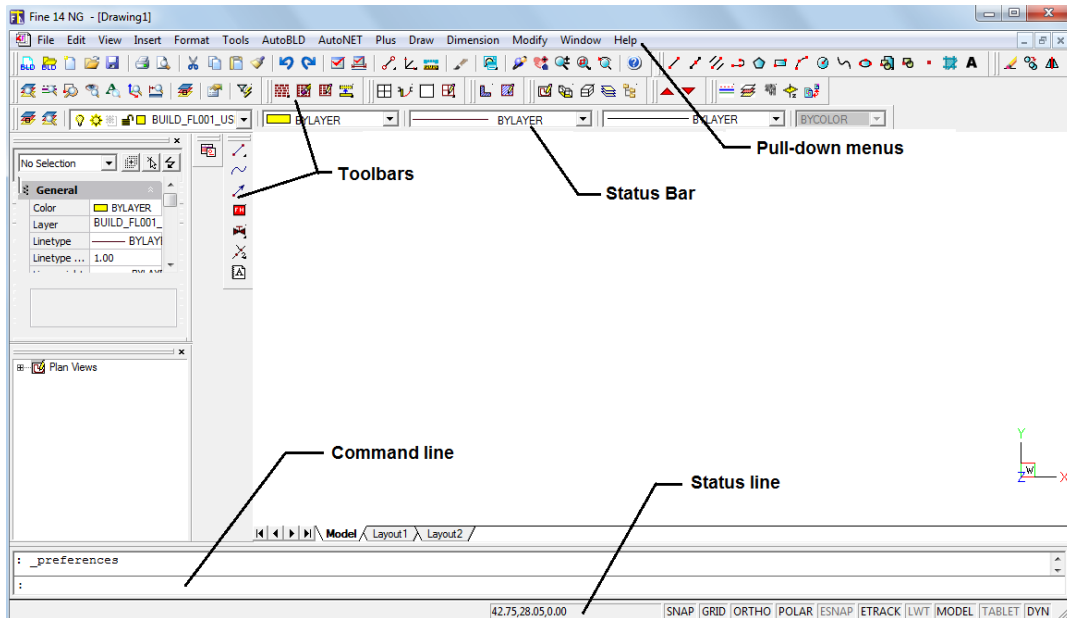

As shown in the above figure, the screen is divided into the following "areas":

- **Command line:** The command line is the area where commands are entered and the command messages appear.
- **Graphics area:** The largest area of the screen, where drawings are created and edited.
- **Cursor:** The cursor is used for drawing, selecting objects and running commands from the menus or the dialog boxes. Depending on the current command or action, the cursor may appear as a graphics cursor (crosshairs), a selection box, a graphics cursor with a selection box etc.
- **Pull-down menus:** Each time you select one of these commands (AutoBLD, AutoNET etc.) a pull-down menu is shown.
- **Status Line:** It is the line on the bottom of the screen where the current level, the drawing status and the current cursor coordinates are displayed. From the status line you can enable or disable tools such as SNAP, GRID, ORTHO etc., which are explained in the following chapter.
- **Toolbars:** You can arrange which toolbars you want to be shown in the screen in each project. To enable or disable a toolbar, in the upper part of the screen (where the existing toolbars are shown) right click with the mouse and select the desired toolbar from the list (as it is shown below).

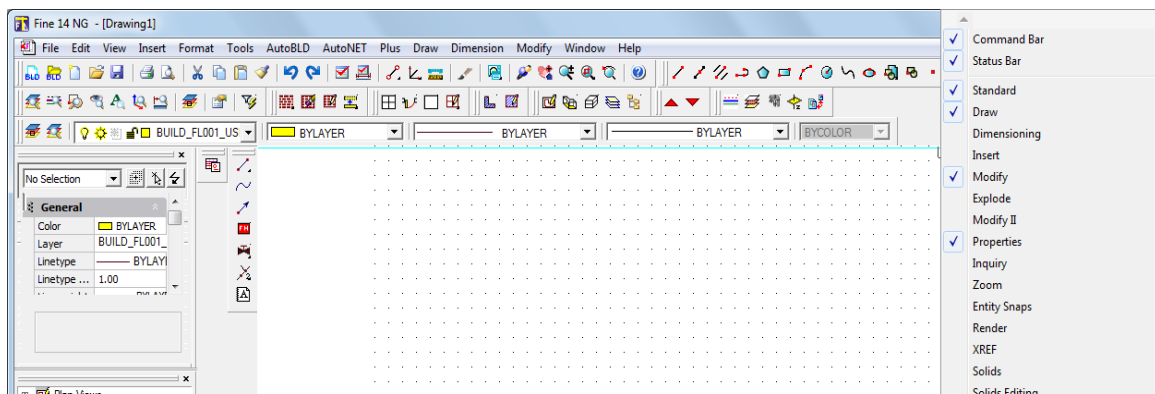

2.3.1 Drawing aids

This section describes the most important drawing aids. These are the commands:

SNAP: The graphics cursor position coordinates appear in the middle of the upper part of the graphics area. If "Snap" is selected, the graphics cursor movement may not be continuous but follow a specific increment (minimum movement distance). To change the increment, right click with the mouse on "SNAP" and choose "Settings". To activate or deactivate it, double click on the "SNAP" icon.

GRID: The screen grid is a pattern of vertical and horizontal dots, which are placed at the axes intersection points of an imaginary grid. The grid can be activated or deactivated by clicking the corresponding icon or by pressing **F7**.

ORTHO: The "Ortho" feature restricts the cursor to horizontal or vertical movement. The status bar shows whether the "Ortho" command is activated by displaying "ORTHO" in black characters. The command is activated or deactivated by clicking the corresponding icon or by pressing **F8**.

ESNAP: The "Esnap" command forces the cursor to select a snap point of an object, which is within the Pick box outline. The esnap points are characteristic geometric points of an object (i.e. endpoint of a line). If you have specified a snap point and move the cursor close to it, the program will identify it with a frame. The "Esnap" command can be activated either by holding down the "SHIFT" key and right clicking the mouse or through the additional toolbar.

2.3.2 Drawing Coordinates

When you need to determine a point, you can either use the mouse (by seeing the coordinates in the status bar or using the snap utilities), or enter the coordinates directly in the command line. Moreover, you can use either Cartesian or polar coordinates and absolute or relative values, in each method (relative coordinates are usually more convenient).

Relative coordinates: Enter the @ symbol (which indicates relative coordinates) and then the x, y, z coordinates (Cartesian system) or the $r<\theta<\phi$ coordinates (polar system) in the command line. The system used (Cartesian or polar) is defined by the "," or "<" symbol respectively. If you do not insert a value for z or ϕ , it will be automatically taken as zero. For example, if you are prompted to locate the second (right) endpoint of a 2m horizontal line, you enter:

@2,0 if you use the Cartesian coordinates (which means that the distance of the second point from the first is 2 m on the x axis and 0 m on the y axis), or

@2<0 if you use the polar coordinates [which means that the second point is at a distance of 2m ($r=2$) and an angle of 0 degrees ($\theta=0$) from the first].

Absolute coordinates: They are specified in the same way as the relative coordinates but without using the @ symbol. The absolute coordinates are specified in relation to the 0,0 point of the drawing.

The measurement system can be activated, deactivated or changed with the **F6** key.

2.3.3 Drawing Basic Entities

In the "Draw" menu you will find the basic drawing entities:

Line: "Line" option is used for drawing segments. When you select "Line" from the menu or type "Line" in the command line, you will be prompted to specify a start point (by left clicking or by entering the point coordinates – relative or absolute – in the command line) and an endpoint (determined in the same way).

Arc: The "Arc" command is used for drawing arcs. An arc can be drawn in different ways: the default method is to specify three points of the arc ("3-Points"). Alternatively, you can specify the start point and endpoint of the arc as well as the center of the circle where it belongs (St, C, End). You will not find it difficult to understand and become familiar with the various methods of drawing an arc.

Polyline: This command allows you to draw polylines, which are connected sequences of line or arc segments created as single objects. The command is executed by either using the menu or typing "pline" in the command line. You will be prompted to specify a start point and an endpoint (by right clicking the mouse or by entering the point coordinates – relative or absolute – in the command line). Then, the command options will appear (Arc, Close, Length etc). Select **A** to switch to Arc mode, **L** to return to Line mode and **C** to close the polyline.

2.3.4 Useful Commands

This section includes brief descriptions of the basic program commands, which will be very useful. These are the commands "Zoom", "Pan", "Select", "Move", "Copy" and "Erase" (you will find them in "View" and "Modify" menus). In particular:

Zoom: "Zoom" increases or decreases the apparent size of the image displayed, allowing you to have a "closer" or "further" view of the drawing. There are different zooming methods, the most functional of which is the real-time zooming ("lens / \pm " button). You can use the mouse to zoom in real time – that is to zoom in and out by moving the cursor. There are a number of zoom options as shown by typing "Zoom" in the command line: All/Center/Dynamic/Extents/Left/Previous/Vmax/window/<Scale(X/XP)>.

Pan: "Pan" ("hand" icon) moves the position of the visible part of the drawing, so that you can view a new (previously not visible) part. The visible part of the screen moves towards the desired area and to the desired extent.

Select: This command selects one or more objects (or the whole drawing), in order to execute a specific task (erase, copy etc.). Select is also used by other CAD commands (for example, if you use the "Erase" command, "Select" will be automatically activated in order to select the area that will be erased).

Move: This command allows moving of objects from one location to another. When the "Move" command is activated, the "Select" command is also activated so that the object(s) you want to move (in the way described in the previous paragraph) can be selected.

After you have selected the desired object(s), you are prompted to specify the base point (using the snap options), which is a fixed point of the drawing. When you are prompted to specify the position where the base point will be moved, use either the mouse or the snap options. After you have completed this procedure, the selected object(s) will move to the new position. Please note that the base and the new location points can be also specified with the use of coordinates (absolute or relative, see related paragraph).

Copy: The "Copy" option allows the copying of objects from one location to another. The "Copy" procedure is similar to the "Move" procedure and the only difference is that the copied object remains at its original location in the drawing.

Erase: Choose this option to delete objects. The procedure is simple: Select the objects you wish to erase (as described above), type "E" in the command line and press <Enter>. Alternatively, you may first type "E" in the command line, then select the object(s) by left clicking and finally right click to erase the object(s).

DDInsert (Insert > Insert Block): This command allows you to insert another drawing (DWG file) or block in the drawing. When this command is selected, a window appears in which you select block or file and then select the corresponding block or file from disk. Then you are prompted to specify the insertion point, the scale factor etc., so that the selected drawing is properly inserted.

Wblock: The "Wblock" command allows us to save part of a drawing or the entire drawing in a file, as a block. When this command is selected, you are prompted to enter the file name and then you select the drawing or the part of the drawing you wish to save. The use of this command is similar to the "Screen Drawing" command in the AutoBLD menu, which will be described in a following section. In order to insert a block in a drawing, you use the "ddinsert" command described above.

Explode: The "Explode" command converts a block in a number of simple lines so that you can edit it in that form. If it is selected, the program will prompt you to select the block ("Select object") you wish to explode.

2.3.5 Grips

Grips are some characteristic points of an object, which appear after it is selected (by moving the cursor on the object and left clicking). The object is displayed with grips (small squares in blue color), which mark control locations and are powerful editing tools (by selecting one grip you can for example, move or change the length of the line). When you click a grip, the following prompt appears in the command line: ****STRETCH**** <stretch to point> /Base point /copy/ undo/ exit. If you press <Enter> (or right click), the first characters of the corresponding word are entered, e.g. "sc and enter" for the "Scale" command).

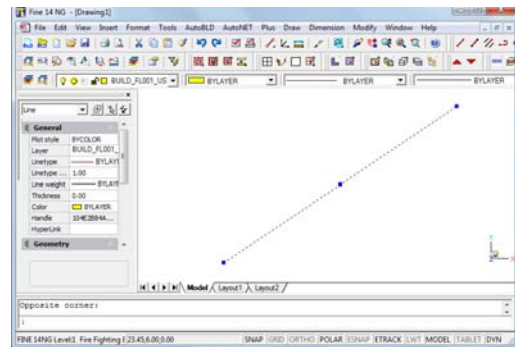

When a command is executed, grips disappear and the objects are deselected. If the command is an editing command (correction or copy), which can be preselected, the objects take part in the execution of the command automatically. In this case, the command overrides the "Select objects" prompt and proceeds. To deselect grips and objects you should press <Esc> twice: once to deselect the objects and twice to deactivate the grips.

In each object the positions of the grips are different. Namely, for a point the grip is the point itself, for a segment the grips are the midpoint and the two endpoints, for an arc the midpoint and the two endpoints, for a circle the center and the quadrants, for a polyline the endpoints of the line and arc segments and the midpoints points of the arc segments, for a spline the spline points, for a block the insertion point, for text the insertion point etc.

2.3.6 Print

This section may be read after you have created a drawing and you want to print it. Any drawing can be printed using a printer or plotter or to a file. Printing is performed using "PLOT" command, selected either from the "FILE" menu or typing it in the command line, provided there is a drawing already loaded.

Viewing a drawing before printing gives you a preview of what your drawing will look like when it is printed. This helps you see if there are any changes you want to make before actually printing the drawing.

If you are using print style tables, the preview shows how your drawing will print with the assigned print styles. For example, the preview may display different colours or line weights than those used in the drawing because of assigned print styles.

To preview a drawing before printing

1. If necessary, click the desired Layout tab or the Model tab.
2. Do one of the following:
 - Choose File > Plot Preview.
 - On the Standard toolbar, click the Plot Preview tool (.
 - Type ppreview and then press Enter.
3. After checking the preview image, do one of the following:
 - To print the drawing, click Plot to display the Print dialog box.
 - To return to the drawing, click Close.

The Plot dialog box is organized in several areas as it is shown in the picture below. For help defining print settings before you print, see Customizing print options.

In the plot window, you can select the printer, the paper size and the number of copies and several plot options such as the style (pen assignments), the orientation etc.

Moreover, you can select the plot scale and the plot area. Before you proceed to printing, you select “Apply to layout” and then “Preview” so as to make any modifications you might want.

To print a drawing

1. If necessary, click the desired Layout tab or the Model tab.
2. Do one of the following:
 - Choose File > Plot.
 - On the Standard toolbar, click the Print tool (). If you click the Print tool, the Print dialog box does not display. Your drawing will be sent directly to the selected printer.
 - Type print and then press Enter.
3. From the Plot dialog box, make any adjustments to the settings.
4. Click OK.

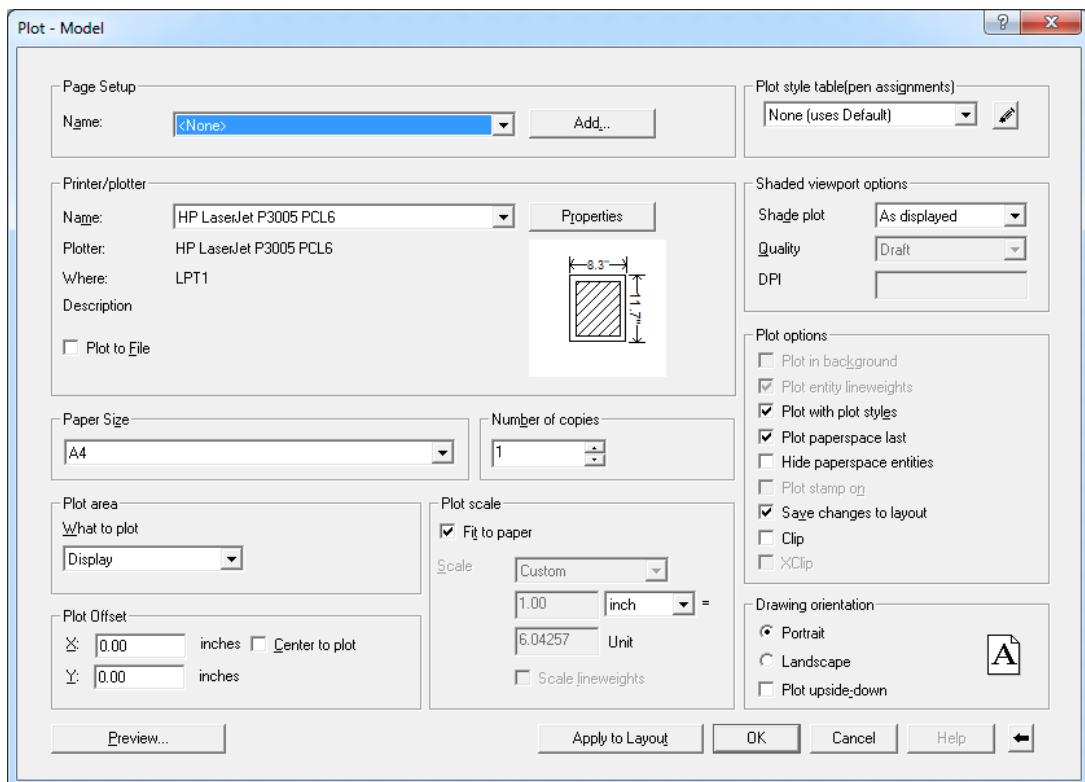

2.3.7 Plus Drawing Tools

Those tools belong to the large group of options under the general menu PLUS. These are a series of additional drawing tools, which have been embodied in the package in order to help the user during drawing, and are described within the Full User’s Guide.

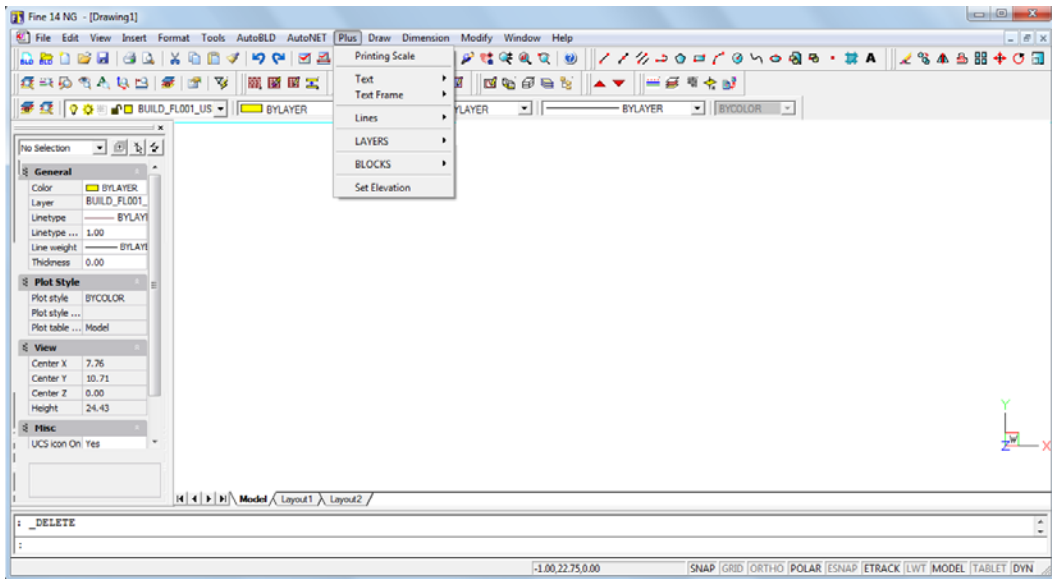

2.4 AutoBUILD: Architectural Drawing

The AutoBUILD option group, as we will see in detail below, includes all the facilities required to insert a building and create an architectural drawing. As it is shown in the corresponding AutoBLD menu, the various options are divided into several sub-groups.

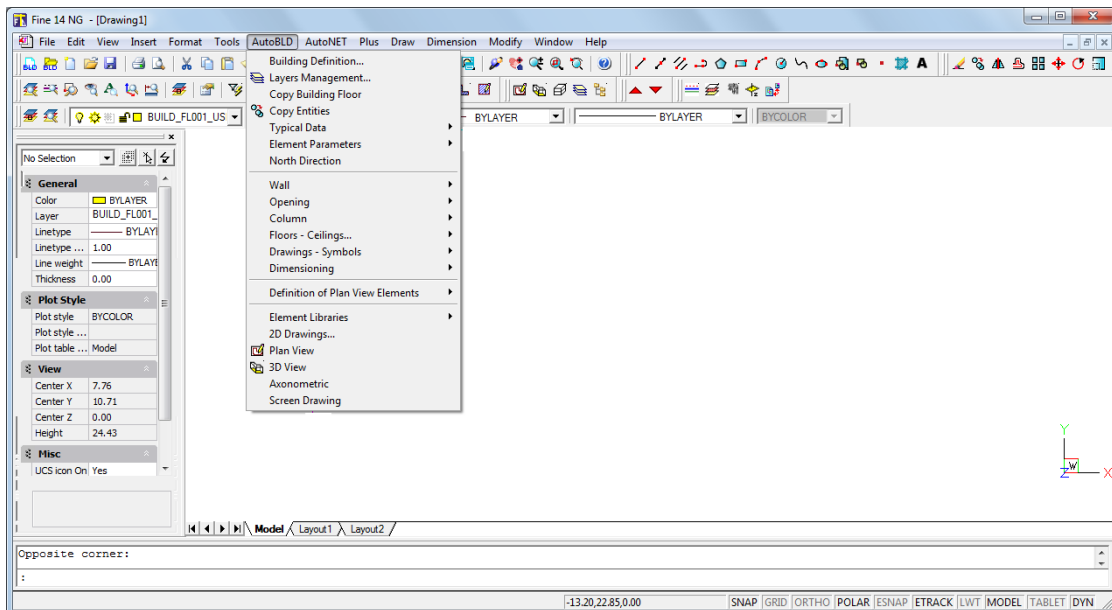

In general, the first sub-group includes commands for the definition of the project parameters, the second sub-group includes drawing commands, the third sub-group includes commands for linking to the calculations and the fourth includes management options for the AutoBLD libraries and commands for the building supervision. In the following sections, the options reported above are described one by one, beginning with the "Building Definition" option.

2.4.1 Building Definition

If you select the "Building definition" option, the floor management menu appears.

On this screen the levels of the project building are defined, which means that you determine the level and the corresponding architectural drawing (a dwg file ground plan) of each building floor (only in case you use a drawing that was created by another architectural designing program). More specifically:

- In the "Level" field, define the Level (floor) number.
- In the "Elevation" field, define the height of the floor level. You can define manually a benchmark for level measurement (e.g. the pavement). You may also define negative levels (e.g. -3 m for the basement).
- In the "Name" field, define the name of the level (e.g. Ground floor).
- In the "File" field, define the path and the name of the relevant DWG drawing file, only if you refer to an already existing drawing (which means that you do not intend to draw the ground plan from the start). If there is no DWG architectural drawing available, leave the filename blank.

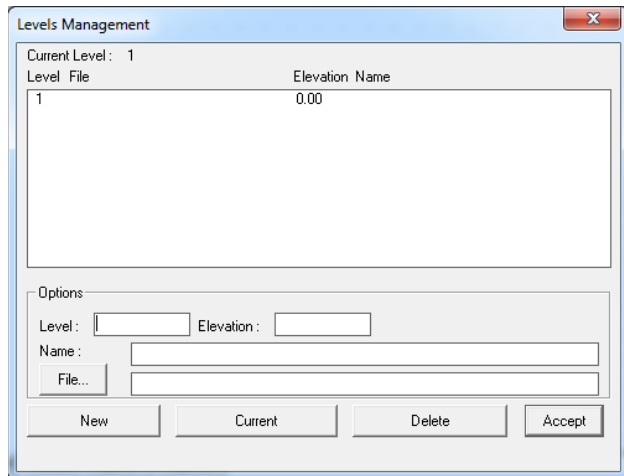

The insertion and the management of ground plans are performed with use of the xref command. At the bottom of the dialog box there are four functions available which are actually used to manage the floor files. More specifically:

- Press the "New" button to save a new floor or the changes in the data of a floor (e.g. level, dwg drawing).
- Use the "Current" option to select the ground plan/file you want to work on each time.
- Select the "Delete" option to delete the floor you want (after you have selected it). The "Delete" command removes the ground plan of the relevant floor in the project.
- The "Accept" command closes the dialog box (it does not save the floor data. This can be managed with the "New" command). FineFIRE enables also the use of a "scanned" ground plan, which is a ground plan in a bitmap file created by a scanner. In this particular situation the steps to follow are described in detail within the User's Guide.

The "Layers Management" option gives you the choice to enable or disable in a quick and practical way (during working) several layers. If you want, you can disable any element group by simply clicking inside the indicator-box of the corresponding group. When the box is checked, the corresponding group is enabled.

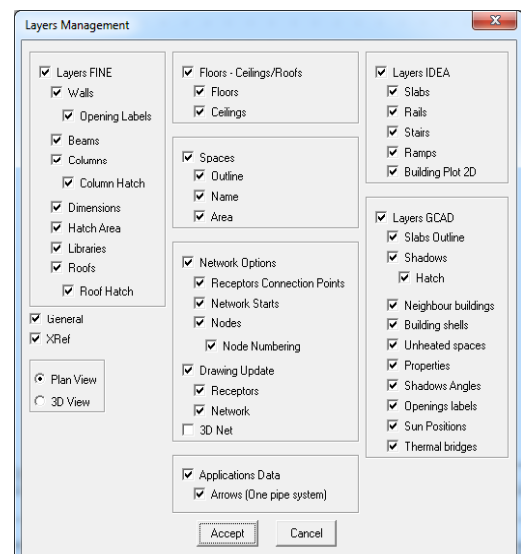

2.4.2 Drawing Walls

AutoBLD menu contains all the commands required for drawing and editing walls, such as parallel moving of walls, trimming, extending, joining and breaking walls as well as placing openings of any kind on them (windows, sliding doors, openings, arches). During the initial drawing, as well as during any modification at any stage, the drawing is automatically updated (e.g. placing an opening on a wall does not break the wall in two parts, the opening moves easily from side to side whether you are working on the ground-plan or on a 3D view and the wall is restored without leaving undesirable lines after deleting an opening etc.).

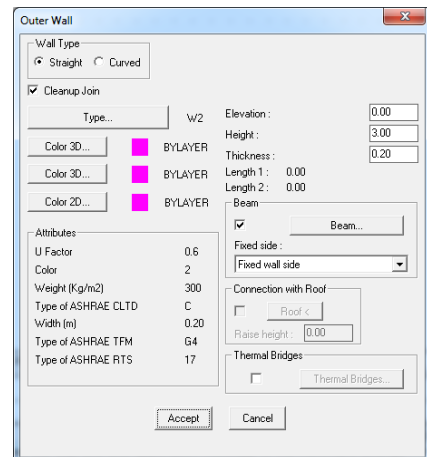

The **Wall** option, located at the second subgroup of the AutoBLD group of commands, includes the Outer, Inner, Outer wall from polyline, Inner wall from polyline and Outline options as well as the option subgroup Modify, Delete, Extend, Break, Join, Trim and Move. The first subgroup concerns the wall drawing, while the second their further processing after being drawn. By selecting Outer Wall, first of all its attribute dialog appears with a series of parameters (type, dimensions, colours etc.), which are described in detail within the User's Guide.

In order to start drawing a wall, you click OK and then follow the instructions shown below:

Outer wall (straight / arc): After activating the command (by pressing <Enter> in the menu), you are required to successively provide:

- i) the starting point of the wall (the application message in the command prompt is: *"Wall start \ Relative to wall \ Toggle shape <Linear>"*)
- ii) the ending point of the wall (the application message in the command prompt is *"Wall end \ Relative to wall \ Toggle shape <Linear>"*)
- iii) the direction towards which the wall shall grow, by providing any point on one of the two half-planes defined by the wall line (the application message in the command prompt is *"Enter Side Point"*).

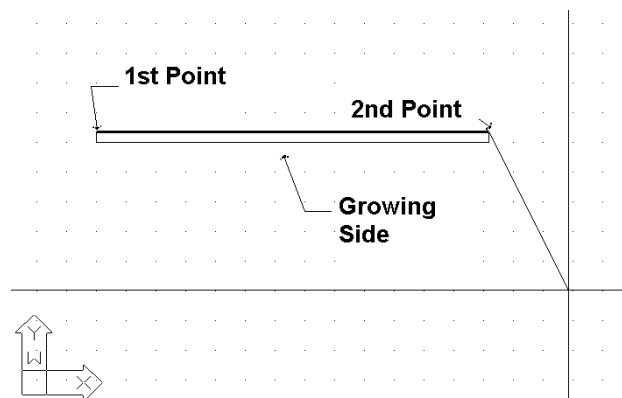

After the above actions, you can see that the wall has been drawn and that you can continue to draw another wall starting from the ending point you defined earlier, unless you right click, which means that you want to stop (or press "ENTER"). You can change the wall drawing from linear into circular, typing T in the following program prompts and pressing <Enter>. During drawing, one can come to the conclusion that the ability of drawing consecutive walls is very convenient since it prevents you from making many movements.

As mentioned further below, in the “Element Parameters” section, the thickness of the wall, its height and its level in relation to the floor level (when the level is 0, the wall starts from the floor), are stored within the “Element Parameters” for the wall. By providing proper values for the wall height and level, any possible case of walls of unequal height can be dealt with. The techniques and tools for creating walls are described in detail within the User’s Guide.

Further to the drawing functions, the program also provides powerful editing tools, such as erase, modify (through the wall dialog box), multiple change etc.. Within the User’s Guide there are complete instructions regarding the above commands plus the applicable commands Copy, Stretch, Extend, Trim, Break, Unify, Mirror, Rotate, Scale, Base point. Two other commands that are widely used while drawing the walls are a) the Undo command, which enables you to reverse the previous command executed and b) the Properties command, which enables you to view (and change) the attributes of the selected wall.

2.4.3 Drawing Openings

Once the command "Opening" is activated, a second option menu is displayed, including a variety of opening types (window, sliding door, door etc) to draw, plus also a set of editing functions such as "Erase", "Modify" or "Move", applied to existing openings.

Window: The option "Window" asks you to select the wall on which the opening will be placed and then define the beginning and the end of the opening (all these actions are carried out using the mouse and pressing <Enter> each time). The window will automatically obtain the data that are predefined in the “Element parameters”, namely the corresponding values for the height, the rise, the coefficient k etc.). Of course, you can draw the window from the ground plan as well as in the three-dimensional (3D) view. During drawing a window, it is very helpful the fact that, after the wall where the window will be automatically placed is selected, the distance from the wall edge is displayed in the coordinate’s position on the top of the screen, while the crosshair is transferred parallel to the wall for supervision reasons. The measurement starting point (distance 0) as well as the side (internal or external) is defined by which one of the two edges is closer and which side was "grabbed" during the wall selection. Similar functionality exists for other types of openings, such as Sliding Doors, Doors, Openings etc. All the details are included within the User’s Guide.

2.4.4 Other Entities

AutoBLD provides tools for designing columns and other elements, as well as drawing libraries including drawings and symbols to place within the drawing (i.e. general symbols, furniture, plants etc.). Details are shown within the User Guide of FineFIRE.

Finally, the Building model of a FineFIRE project can be viewed through the commands:

- Plan View (2D): The two-dimensional plan view of the respective building level is shown.
- 3D View: A three-dimensional supervision of the ground plan of the current floor (with given viewing angles) is shown.
- Axonometric: Provides three-dimensional supervision of the whole building (for all floors), with the given viewing angles as they have been selected in "Viewing Features".

2.5 AutoNET: Network Drawing Principles

The option group AutoNET includes all those tools the designer needs in order to draw (and then calculate) the Fire fighting installations. Below are described the general AutoNET commands and you will find the specific commands for Fire fighting in the next chapter.

Drawing Definition: The layers for each installation are organized properly and the information is shown on the respective dialog. The command "Color" is used to assign the desired color to each network while the command "Linetype" is used to select the desired line type.

Copy network of Level: AutoNET enables copying of typical (installation) plan views and pasting them on other levels through this command, which functions similarly to the "copy level" option of the AutoBLD menu. When you select this command, the program prompts you to select the network you want to copy (you can select it in a window), and after you do it and press ENTER, it asks you to give the number of the level in which you want to copy it.

The commands and the basic principles and rules for drawing the network are described below:

Network Drawing: The installation network drawing is carried out with a single line, by drawing lines and connecting them to each other, exactly as the network is connected in fact. You should keep in mind some general principles regarding drawing and connecting between straight or curved, horizontal or vertical network branches.

Horizontal & Vertical Piping: In any case, the piping drawing is carried out exactly as the line drawing (in AutoCAD or 4MCAD). You are able to draw horizontal or vertical pipes. The pipe installation elevation is the current elevation. Modification of the pipe installation elevation is possible through the menu PLUS -> Set elevation (or if you type the command "elev"). If you type "elev" (in the command line), you are prompted to determine the new current elevation. Press <Enter> if it is 0 or type the value you want. At this point it should be emphasized that, if a horizontal piping which is found on a specific level is drawn and connected to another piping or a contact point (receptor), the program automatically "elevates" or "lowers" the pipe so that connecting to the other pipe or receptor, respectively, is possible. In this way, the program facilitates the drawing of piping in three dimensions while you are actually working in a two-dimension environment. In any case of a network design, all facilities provided by AutoCAD can be utilized through relative coordinates.

Vertical pipe Drawing: Drawing vertical pipes which cross floors (one or more) is possible through the option "Main Vertical pipes (Building)". When the respective option is selected from the menu, the program asks for the pipe position ("Enter xy Location") and then for the height of the starting point ("Enter Height for First Point") as well as the height of the ending point ("Enter Height for Second Point"). For example, if you want to draw a vertical pipe from 0 to 3, by inserting the location point (XY) and then the numbers 0 and 3 successively, the symbol for direction change appears on the ground plan and in 3D View.

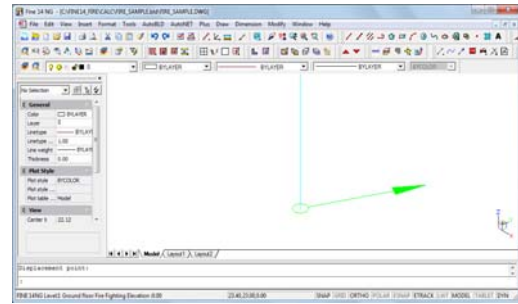
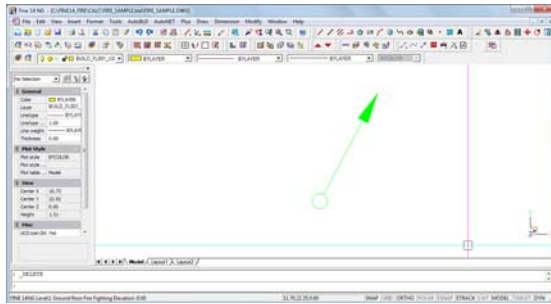

Vertical sections within the same floor:

If you want to elevate or lower a pipe within the same floor, you can use the relative coordinates. For example, if you have drawn a horizontal pipe (in elevation of 0 m) and you want to elevate it to 2 m, when in the command line asks for "Enter next point", you will type @0,0,2 and continue drawing the pipe (see the adjacent photo). In the same way, if you want to lower the pipe by 2 m, you will type @0, 0,-2.

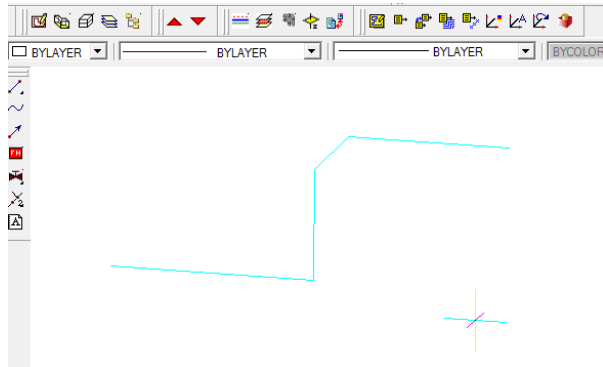

Drawing Curved Pipes: You can draw curved pipes by inserting the points from which the curved pipe is to pass (give at least 3 points). The respective command prompts for the following:

- First point: Insert the starting point of the pipe.
- Next point: Insert next point, the one after that and so on (successively), defining the pipe routing in this way and to stop press <ENTER> or right click of the mouse.

You can easily modify curved pipes using "grips". As soon as the pipe is selected, grips appear which you can select and move, altering this way the pipe routing. In the Bill of Materials and the Calculations sheet, the program will measure the pipe length precisely.

Connecting network sections: Connections between network sections (horizontal, vertical or both) as well as between network parts and appliances can be easily executed by using the "Snap" commands. For example, suppose that the two horizontal parts of the ground plan below, which are placed in different heights, have to be connected. If you start by "grabbing" the "upper" pipe end and then end up at the "lower" pipe end, the result in the three-dimension representation will be as on the right.

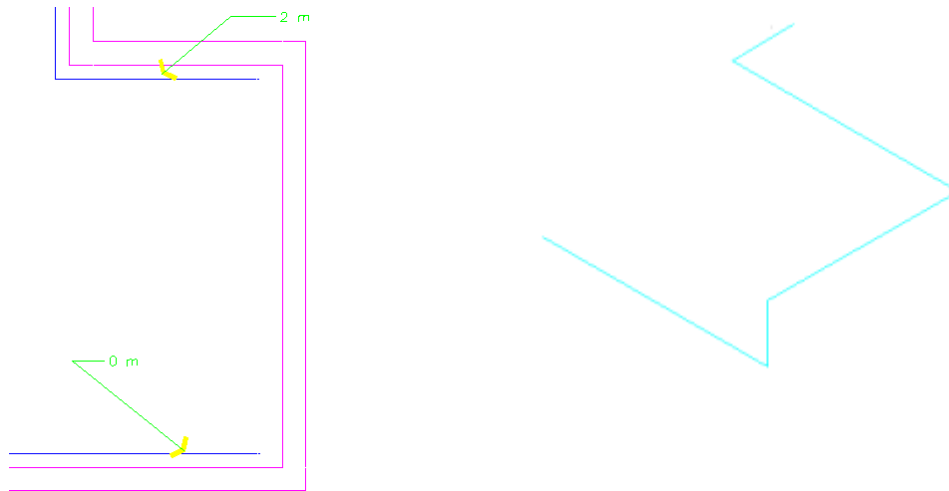

Special Commands for Pipe Construction: This is actually a set of commands aiming to facilitate the drawing of the installation piping. More specifically, there are two basic commands:

- **Multiple supply pipes:** Multiple pipes can be drawn, when the in between distance is known, by simply defining the routing.
- **Pipe parallel to Wall:** A pipe parallel to the wall (or walls) that you mark is drawn, with a given distance from the wall, in printing mm (which depends on the printing scale as well). The program asks for the first point and afterwards the wall or the walls (successively) parallel to which (in a certain fixed distance) the pipe is to be drawn.
- **Pipe parallel to Points:** A pipe is drawn parallel to the points you defined (supported by automatic snap), with a given distance from the crooked line defined by these points. The program asks for the first point and then for the other points (successively) parallel to which is desired to have the pipe drawn. When all points are inserted (and you right click the mouse), the distance will be requested.
- **Pipe parallel to Wall (or Points) and Receptor Connection:** This is a particularly useful command similar to the two commands above "Pipe parallel to wall" and "Pipe parallel to points", which, however, enables selecting the receptors to be automatically connected to the routing which will be drawn parallel to the walls or the points. Therefore, it is possible to connect a whole set of appliances to the nearest vertical or horizontal pipe, with only 2-3 moves.

For better understanding of the command function, assume that in a given room with its appliances is desired to install a pipe parallel to the wall and connect the appliances to it. The steps are the following:

- Select the "Pipe parallel to points and receptor connection" command and the following options will appear:
- Select receptors: Select the receptors to be connected to the pipe applied in a parallel arrangement against the wall by defining certain points on the wall.
- Enter the first point & enter the next point: Provide the points parallel to which you want to install the pipe. The points are shown on the drawing with an X.
- Distance from a point <1.00>: Provide the distance in printing mm where the pipe is going to be drawn starting from the inserted points.

The program draws the pipe and connects it to the receptors.

Modify an existing network: You can edit an existing network by using any CAD command (i.e. copy, move or erase etc. of a network section) or utility (i.e. grips) during the design process. The only rules to apply here are the following: Pipes supplying the appliances (receptors) should be connected to the touch points of these receptors. Obviously only one pipe can be connected to a touch point. The connection with the touch points which appear as red "stars" in the ground plan can be executed with the "esnap" function. Piping can be branched to one another and extend in any way as long as they do not form loops, something which does not apply to reality anyway. If however a mistake occurs, the program (during the recognition procedure) will perform all checks and indicate the mistake and its location. A necessary step before the "Network recognition" is defining the point "1" where the network starts, which is the supply point "1". In reality, this point corresponds to the Fire Pump. In FineFIRE application, the menu includes specific options, so that you can be easily guided when drawing any installation.

Placing the receptors: Placing a receptor can be done simply through the following steps:

- Select a receptor (from AutoNET->Receptors window) and press "OK" (or alternatively double click). It can be observed that the receptor moves on the ground plan with the graphic cursor.
- If you move the mouse properly, the receptor can be carried in such a way that its base point (which coincides with the cross of the graphic cursor) can be placed in the desired point. Right click or <ENTER> to confirm your selection.
- If you move the mouse again, the receptor will rotate around the base point. Thus, if you confirm the angle in which you want to place the receptor (again by right clicking), the receptor "freezes" in its final position.

You can also insert and place either the whole receptor or only its touch points in the ground plan by checking one of the two options in "Receptors" window. This is significant when an existing ground plan includes drawn receptors and there is no need to redraw them, but just move the touch points so that the information for the respective supplies will be available.

Regarding the installation height of a receptor, it should be pointed out that receptors are always installed in the current height. The current height can be changed with the "Set elevation" command (from the PLUS menu).

Fittings: The "Fittings" command selects the accessories to be also inserted in the drawings, which applies exactly the same as the receptors. Fittings have "touch points" upon which the piping will be connected so that the network can be recognized. A symbol may also have more than one touch points (e.g. a collector), in which case the fitting will be numbered as a junction point in the "Network Recognition". The program provides the capability of cutting off the line automatically when a symbol is inserted on the line, exactly where the accessory interjects. This capability is defined by the indication of the accessories box "Break Pipe". If this option is activated, then the program will automatically "Break" the pipe when the accessory is placed. Moreover, the "Move Symbol" indication is in the same box, which defines whether the accessory will be moved in relation to the position it was initially placed (so that it will be placed parallel and on top of the pipe) or the pipe will be moved (so that the accessory can be attached).

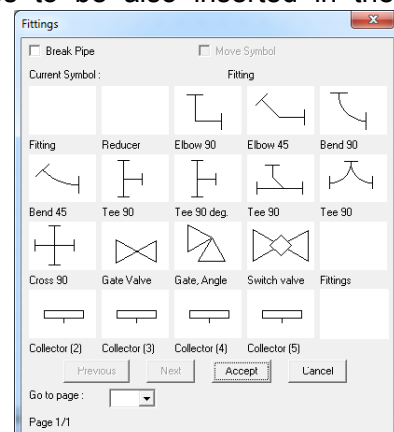

Symbols: "Symbols" include various general symbols, layout of machines and other drawings that can be used in the corresponding installation.

Network Recognition and Numbering: Since the network has been drawn according to the current rules and the supply point has been determined, the "Network Recognition" option converts the network in the required standard pattern and updates appropriately the calculation sheet. During updating, junction points and receptors are numbered on the ground plan. Note that if a receptor is not numbered, it means that it is not connected to the network. Besides, if a network section has a different color, it is not correctly connected to the network. Connect it or select "Break at selected point" at the connection point with the previous pipe.

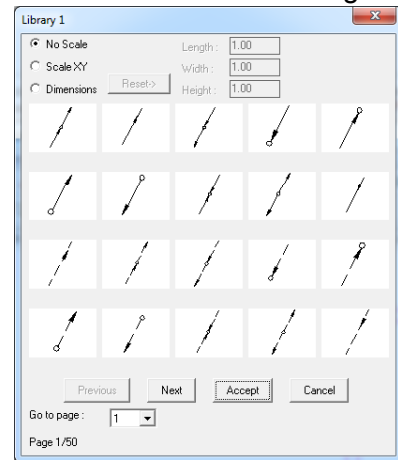

Calculations: The "Calculations" option leads you to the corresponding calculating environment, which means that a new window of the current application is "opening", while FINE FIRE remains "open". In order to transfer the data from the drawings, you should select "Update from Drawing" in the "Files" menu of the corresponding calculating application (in order to carry out the corresponding calculations, answer "Yes" to the question "Calculate" that appears). It has to be noticed that the numbering of the sections, the lengths of the network sections, the receptors with their supplies and the fittings (from the piping routing) are transferred in the calculation sheet. Of course, if you want to, you can intervene in the calculations in order to make any modifications.

Legend: The "Legend" option creates a legend with all the symbols that have been used in this specific project. By selecting it, the program asks for the location where the Legend is going to be inserted. Use the mouse to define the location and the legend will appear automatically on your screen, exactly under the location point.

Vertical Diagram: This option is used for the automatic creation of the vertical diagram of the installation and in its appearance on the screen, within few seconds. In case there is already a vertical diagram, the program asks if you want to update it. It is obvious that, in order to create a vertical diagram, you should draw and identify a network and enter the calculation sheet, so that the program knows all the data needed for the vertical diagram creation (pipe dimensions, junction points numbering, etc.). By the "creation" command the window of the vertical diagram's manager appears on screen. This window is composed of two parts, the part with the network tree and the part with the vertical diagram. Through appropriate commands, you can intervene in several ways on the output of the diagram:

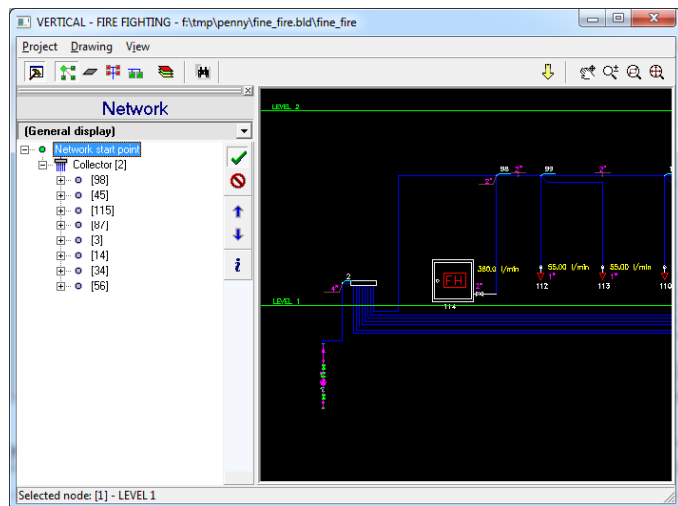

- Enable or disable various sections of the network
- Change the order of the columns of sub-networks in the vertical diagram
- Change the sub-networks direction connection on the vertical columns (right or left)

- Read the information of each node
- Describe the sub-networks

The changes done in the vertical diagram with the help of the above icons are displayed in real time, in the second part of the window. On the upper side of this window there are also icons for processing the diagram (real time zoom and pan, zoom extends etc.). In addition, in the upper-left side there are some other icons having to do with the appearance of the screen, such as the hiding of the left part of the window, the appearance of the level names and heights on the left to be edited, the appearance of the numbers of the receptors, the layers and others.

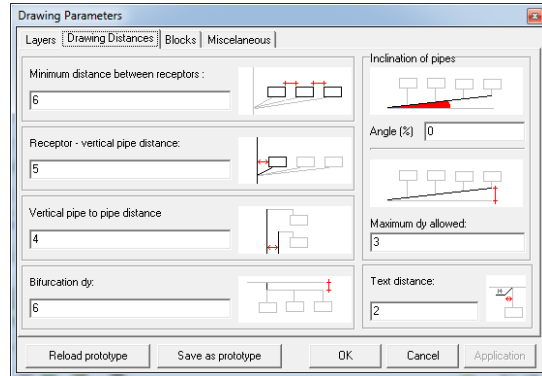

Finally there are some options for the initialization of the vertical diagram, its reconstruction and the definition of the drawing parameters. In particular, the drawing parameters depend on the application and include the following options:

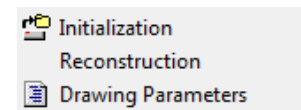

Layers: Through a supervisory window table, you can define the drawing scale, the colors corresponding to the various layers and the height of the texts (in mm drawn on paper) placed on the vertical diagram.

Drawing distances: The drawing distances that will be considered on the creation of the diagram, are also defined on mm drawn on paper.

Blocks: There can be defined on each application different network starting points and type of tables. You can choose from a set of dwg drawings.

Miscellaneous: A set of attributes concerning the form of the vertical diagram is defined, considered as collector, whether the z height information will be considered in the diagram creation and whether the sub-networks pipes on the vertical diagram will be placed over or under the receptors. Finally, it should be mentioned that during the editing procedure concerning the vertical diagram manager, if there are mistakes the program displays the proper messages and warnings.

Libraries Management: This option leads to a submenu including the options "Numerics", "Drawings" and "General symbols". The first option leads to the libraries with all the numerical data of the materials. The "Drawings" option leads to a dialog box where the following data can be seen, regarding each application. The "General symbols" option leads to a dialog box where several symbols can be seen and edited.

2.6 AutoNET: FineFIRE Installation

The previous chapter described the drawing principles, while the present one describes those commands in relation to the special features of FINE FIRE.

Regardless of the fact if there is an AutoBLD building model, an external reference, a digital image or even no architectural drawings, a Fire Fighting installation can be drawn and then calculated.

Although there are no limitations regarding the order of actions followed in drawing an installation, the following order is suggested:

- Create one or more fire fighting spaces
- Place the receptors in them (Sprinklers, Fire Hose Cabinets etc.) manually or automatically
- Draw the horizontal pipes
- Connect the receptors to the pipes
- Draw the vertical pipes
- Connect the horizontal to the vertical pipes
- Define the Supply point(s)
- Run “Network Recognition”
- If there are no mistake messages, proceed to the calculations

Create fire fighting space: With this command you can draw a fire fighting space where the sprinklers will be placed. Type a name for the space, define a minimum density and select the type of the hazard among the categories “Light”, “Ordinary” and “High’ (the hazard description is only for reference on reports). The space can be defined either by points or by polyline.

Modify fire fighting space: You can change an existing fire fighting space by selecting its name, pressing <Enter> and editing the space.

Placement of the Receptors to the drawing: We select “Receptors” either from the AutoNET menu or from the “Fire Fighting” toolbar. When all receptors' window appears, select the type of the receptor, which will be placed at the specific point.

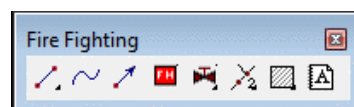
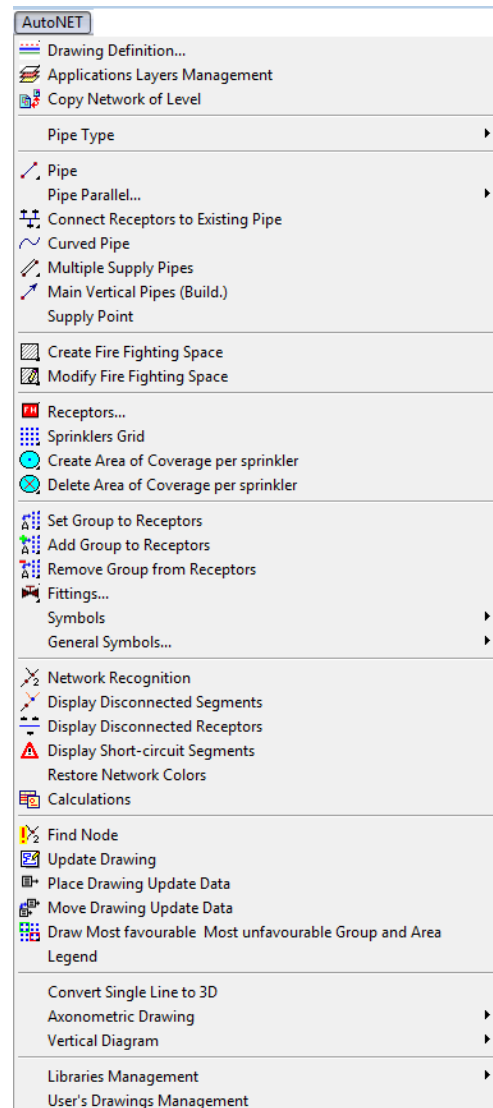

The receptors are placed as it was described in the previous chapter. In case they already exist on the architectural plan view, then we just click at the “Touch points only” field.

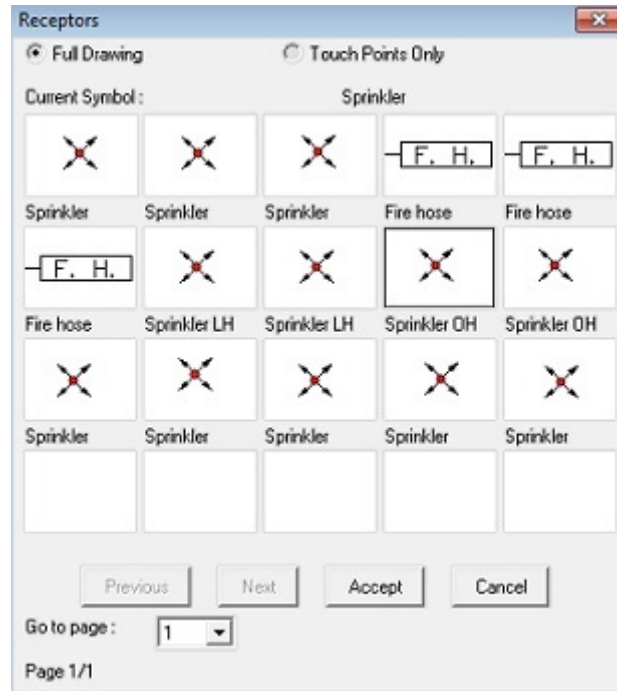

Sprinklers Grid: If you want to draw a sprinkler grid automatically, in this window fill in the following fields:

- **Receptor:** From the “Receptor” button select from the library the type of the sprinkler and automatically the “Maximum area of coverage” will be filled in.
- The next step is to select the area of the grid by:
 - giving points on the drawing
 - selecting a polyline
 - drawing automatically a rectangular area or
 - choosing a fire fighting space that has already been drawn

Note: If the selected area is not rectangular, the program frames it with a rectangle and calculates its surface and the number of the sprinklers which will be placed inside the selected area.

Automatically, the “Frame dimensions” and the “Area” are updated and the program:

- Proposes a minimum number of sprinklers.
- Suggests the number of the rows and the columns. For rectangular areas, the number of the sprinklers is the result of the multiplication between the rows and the columns. For non-rectangular areas, the program calculates the rows and the columns of the framed area and shows the number of the sprinklers which will be placed inside the non-rectangular area.
- **Grid angle:** In order to select the angle of the sprinklers array, click on one of the edges of the selected area.

- Next, you give the number of the “rows” and the “columns” you want (you can follow the suggestion of the program or select your own design). When the “number” fields are filled in, the program automatically calculates the vertical and horizontal distances from the outline and the intermediate distances. You can edit the distances in any of these fields and the program will make again the calculations.
- **Reset distances:** This button is used if you made changes in the distances and you want to reset them in the initial results of the program.

Create area of coverage per sprinkler: This command divides the fire fighting space in sprinkler coverage areas. The program checks if each sprinkler can cover its area and if it can, the coverage outlines are in green color. If it cannot, the outlines are in red color and if the area intersects with another, the outlines are in yellow color. Each time you select again the command and choose the same fire fighting space, the program automatically deletes the previous coverage areas and recreates them.

Delete area of coverage per sprinkler: This command deletes all the coverage areas of a fire fighting space, by selecting the space and pressing <ENTER>.

Set group to receptors: This command is used for creating a group of sprinklers. Select one or more sprinklers of the drawing and type the number of the group on the command line.

Add group to receptors: The same sprinkler can belong to multiple groups. With this command, you can select one or more sprinklers that are already part of a group and type the number of the additional group which you want them to be part of.

Remove group from receptors: This command removes one or more sprinklers from their groups by selecting them and pressing <ENTER>.

Fittings: You can select “Fittings” either from the AutoNET menu or from the “Fire Fighting” toolbar. When all Fittings’ windows appear, you select the type of the fitting, which will be placed at the specific point.

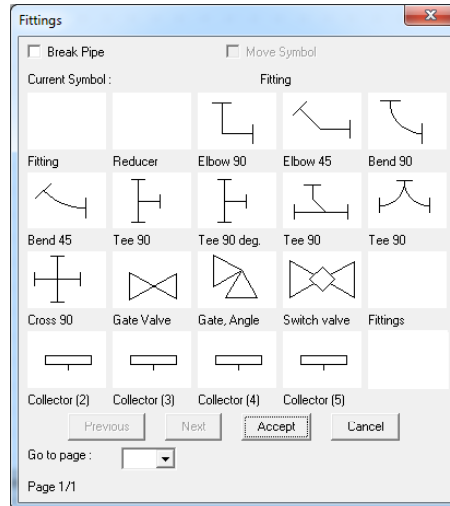

Horizontal networks design: After you place the appliances, as described earlier, you proceed with the design of the vertical and horizontal pipes of the level. After the design of the vertical and horizontal pipes, you perform the connection of the piping to the receptors. For the reduction of both the time needed for the specific work and of the errors we suggest the use of the “**Connect receptors to existing pipe**” command. When you select it, the program asks you to define the appliance(s) which will be connected to a specific part of the pipe, then the pipe and when you press <ENTER> they are automatically connected.

Design of the networks’ Vertical pipes: You draw the vertical pipe as it was described in the previous chapter, giving the pipe position, the starting and the ending points. We must point out that the heights of the vertical pipes are dependent upon the level heights of the building that you defined in “Building definition”. All pipes will be connected to the vertical pipes through the “Perpendicular” snap point.

Set of Supply Point(s): From the edge of the vertical pipes connect the horizontal pipes, and place the supply point to the end of it. It is important to use the **Endpoint** snap to connect the supply point to the horizontal pipe.

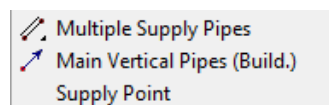

Network recognition: Select “Network recognition”, in order for AutoNET to recognize the network and prepare the files for the connection with the calculations. During the recognition, messages warn you for potential drawing errors. For example there might be closed routes of the horizontal pipes, points at which different types of pipes end, lack or false placement of the supply point, elements unconnected etc. Besides, no “white” parts should appear on the network, which means that they haven’t been “recognized”. As soon as you correct them, run again the “Network recognition” and if there are no mistake messages, proceed to the calculations.

Notes:

- If you have drawn a fire fighting space without defining a "Minimum density", you will get a warning message. Nevertheless, you can proceed to the calculations without a problem.
- The warning messages "Sprinklers with Density=0" and "Sprinklers with maximum coverage =0" do not apply to the calculation methods "NFPA Ordinary Hazard pipe schedule" and "Hydraulic Calculations".
- You can ignore the warning messages "Sprinklers with Density=0" and "Sprinklers with maximum coverage =0" if they are shown for the fire hose.

Calculations: When the control is completed we're ready to go to the computing environment. By selecting "Calculations" the Fire Fighting calculations are displayed in a new window. When select "Files" and "Update from drawing", the data is transferred at the calculation sheet.

Find node: You can easily find any node you want by typing its number on the command line.

Update Drawing: After the calculation part of the program is completed, save the project file, return to the drawing program (FINE FIRE) and select "Update Drawing". The following window will open and you will select the information you want to be shown on the drawing. Particularly:

- In the *left part of the window*, you select the information you want to be shown regarding the **pipes**. You can select to see information for all the pipes (choose "Select All"), some of them (choose "Select from Drawing" and select the pipes from the drawing) or none (choose "Deselect All"). Furthermore, below this list, you can choose which information you want to be shown, such as the length, the flow rate, the diameter etc. If you do not want, for example, the "Velocity" to be shown, select it and uncheck the "Selection" button.
- In the *right part of the window*, you select the information you want to be shown regarding the **receptors**. You can select to see information for all the receptors (choose "Select All"), some of them (choose "Select from Drawing" and select the receptors from the drawing) or none (choose "Deselect All"). Furthermore, below this list, you can choose which information you want to be shown, such as the receptor name, the water flow etc. If you do not want, for example, the "Group" to be shown, select it and uncheck the "Selection" button.

Finally, to place the information on the drawing, select either "Manually placement" or "Auto Placement" (the program automatically chooses to place the information for each pipe and receptor in the best position without covering each other).

You can easily move the position of the data on the drawing selecting "Move drawing update Data" (from the AutoNET menu) or change their height and style from the "Space text style" command (from the AutoBLD -> Element parameters) and run "Update drawing" again.

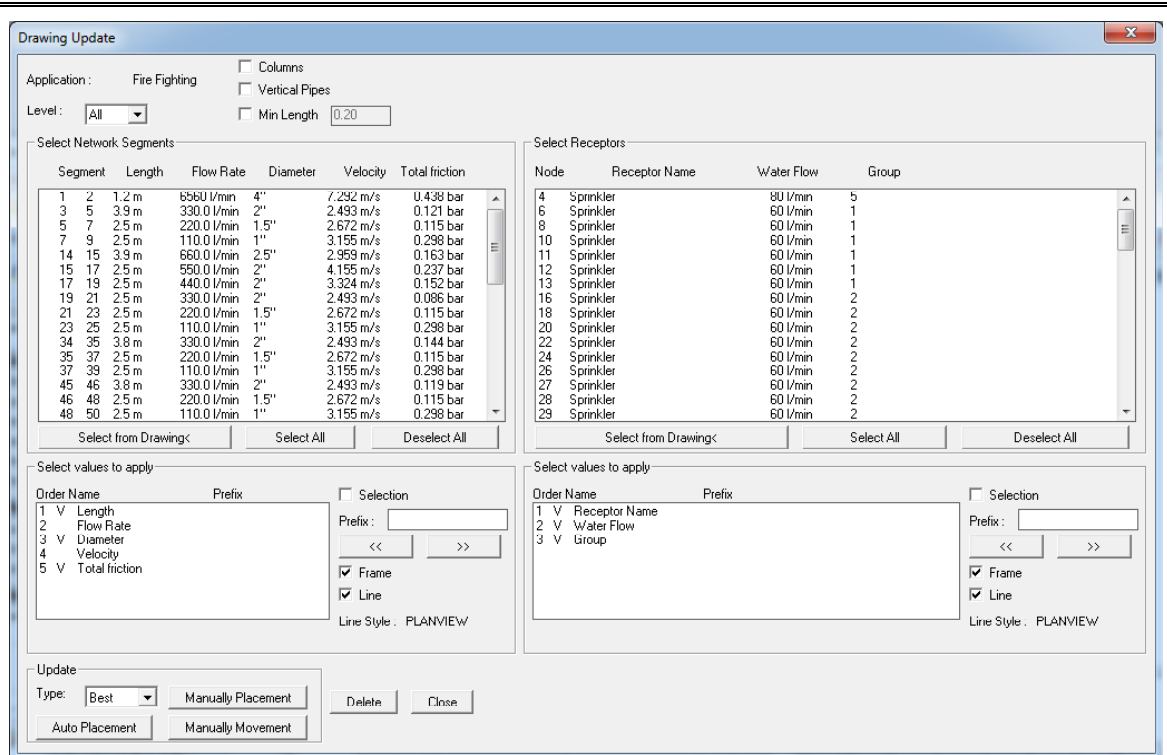

Draw Most Favourable, Most Unfavourable Group and Area: With this command the program automatically highlights the most favourable (with green color) and unfavourable (with red color) areas. Furthermore, the program finds the 4 sprinklers under consideration of the favourable area (in green linetype) and of the unfavourable area (in red linetype).

Other drawing actions – Completion of the draws: Next, we place a control faucet in front of each apartment or property, or wherever else it is required. From the **“Fittings”** dialogue box we select the faucet having checked the **“Pipe Cutting”** box. We select the pipe and place the faucet. Apart from that, we must place the counters (flow-meters). The draws regarding the counters, general assemblies manufacturing details and so on can be selected from **“Details”** command (AutoNET -> Symbols) or from the **“Fire Fighting”** toolbar and the corresponding icon.

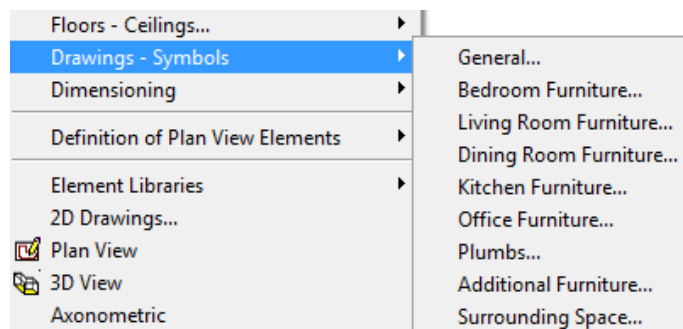

Finally, we can attach a **legend** as it was described in the previous chapter.

Convert single line to 3D: This command converts the single line pipes of the drawing to 3D. The diameter of the 3D pipes is directly related to the calculation results and therefore, before you run this command, you have to update the drawing.

Axonometric Drawing: The axonometric drawing produced automatically with the use of FINE provided that the network was designed at the specific program. From AutoNET we select **“Axonometric Drawing”** > **“Create”**. Then the following window appears:

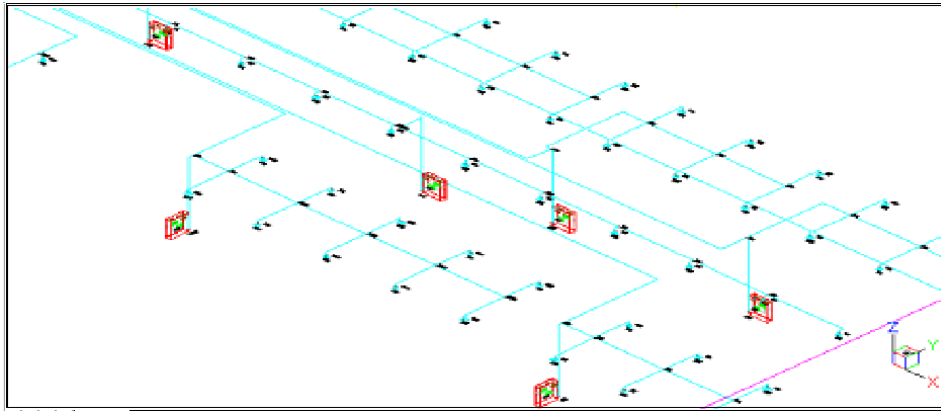

Vertical Diagram: The vertical diagram is produced automatically with the use of FINE FIRE provided that the network was designed at the specific program. From AutoNET we select “Vertical diagram” > “Create”. Then the following window appears:

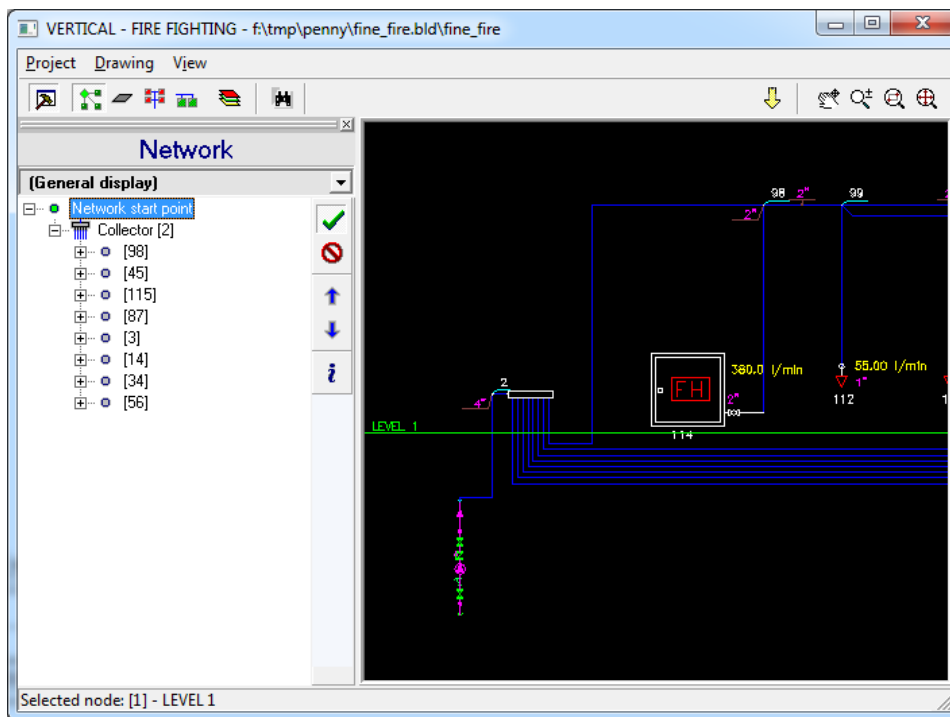
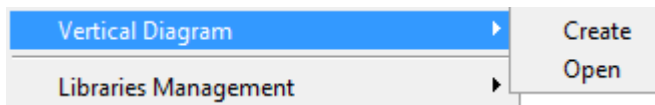

You can apply all the desired changes as it was described in the previous chapter or close the window, which will result to the display of the design in a DWG form, which you can modify using the provisions of CAD programs.

3. Calculations

3.1 Introduction

This chapter provides a description of the Calculations Component of FineFIRE. This module can be used either independently, by filling the numeric data, or in co-operation with the CAD component of FineFIRE, in which case the calculation environment acquires the data directly from the drawings.

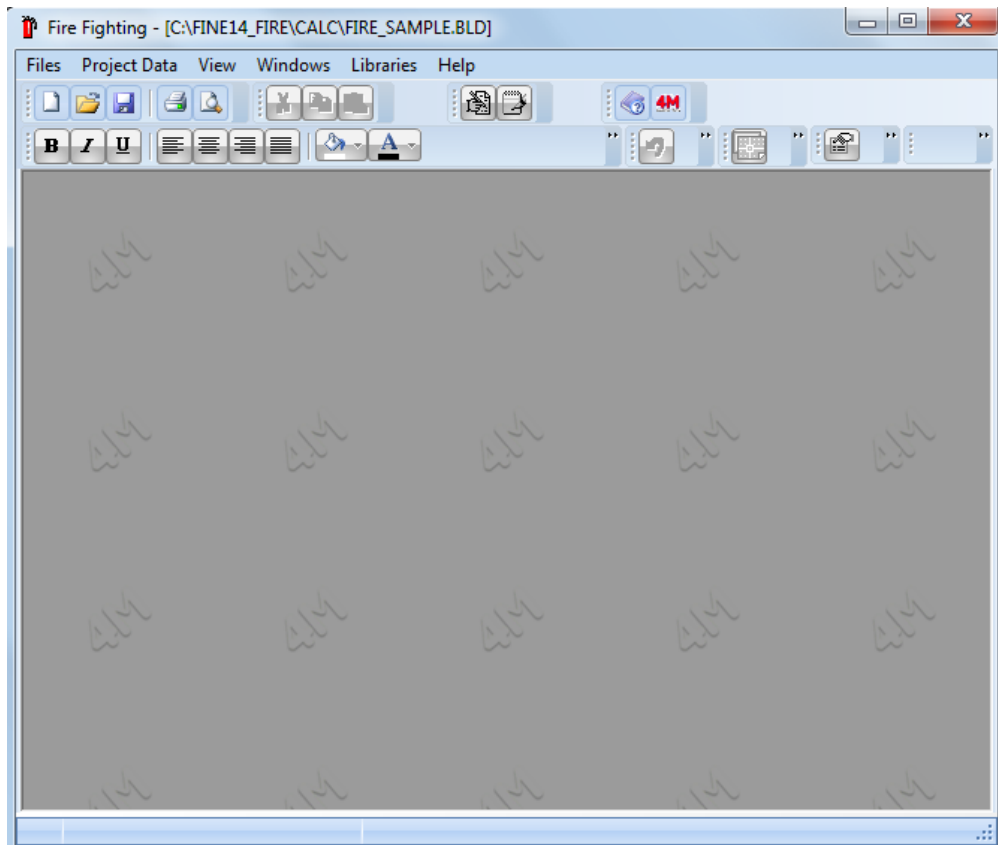

At the top of the application window appear the general options of each application menu, constituted of the group options **"Files"**, **"Project Data"**, **"View"**, **"Windows"**, **"Libraries"** and **"Help"**.

The core of the calculations is the calculation sheet, a spreadsheet-like environment with specific capabilities and facilities tailor-made for each application. More specifically, regarding FineFIRE, which refer to an installation network, the calculation sheet is shown in a spread sheet using lines corresponding to the network branches, and columns containing primary data (e.g. length) and results of calculations (e.g. water velocity) for each branch. An example of such a sheet for the Fire Fighting Application is shown below:

Fire Fighting - [F:\TMP\PENNY\FINE_FIRE.BLD] - [Calculation Sheet]

Files Project Data View Calculation Sheet Windows Libraries Help

ARIAL 9 100%

Network Section	Pipe Length m	Type of Receptor	Receptor Capacity (l/min)	Peak Capacity (l/min)	Desired Pipe Size mm	Pipe Size mm	Max Velocity m/s	Water Velocity m/s	Type of Fittings	Fittings friction drop (bar)	Pipes friction drop (bar)	Total Friction Loss (bar)	Circuit Polar Angle	Receptors Group	Required Pressure of Receptor (bar)	D D (b)
1	1.2		6560	3810	4"	5	7.292	F-1	0.372	0.066	0.438					
2	2.3		710.0	380.0	2"	5	2.871	F-2	0.189	0.182	0.371					
3	3.4	2	380.0	380.0	2"	5	2.871	F-3	0.078	0.069	0.147		5	4.500	0.0	
4	3.5		330.0	330.0	2"	5	2.493	F-4	0.059	0.062	0.121					
5	5.6	1.5	55.00	55.00	1"	5	1.578	F-3	0.024	0.023	0.047		1	1.400	0.0	
6	5.7	2.5	220.0	220.0	1.5"	5	2.672	11	0.054	0.062	0.115					
7	7.8	1.5	55.00	55.00	1"	5	1.578	F-3	0.024	0.023	0.047		1	1.400	0.0	
8	7.9	2.5	110.0	110.0	1"	5	3.155	8	0.149	0.149	0.298					
9	9.10	1.5	55.00	55.00	1"	5	1.578	F-3	0.024	0.023	0.047		1	1.400	0.0	
10	9.11	1.3	55.00	55.00	1"	5	1.578	F-3	0.024	0.020	0.044		1	1.400	0.0	
11	7.12	1.3	55.00	55.00	1"	5	1.578	F-3	0.024	0.020	0.044		1	1.400	0.0	
12	5.13	1.3	55.00	55.00	1"	5	1.578	F-3	0.024	0.020	0.044		1	1.400	0.0	
13	2.14	16.1	1040	660.0	2.5"	5	2.959	F-2	0.201	0.256	0.457					
14	14.15	3.9	660.0	660.0	2.5"	5	2.959	F-5	0.101	0.062	0.163					
15	15.16	1.5	55.00	55.00	1"	5	1.578	F-3	0.024	0.023	0.047		2	1.400	0.0	
16	15.17	2.5	550.0	550.0	2"	5	4.155	11	0.129	0.108	0.237					
17	17.18	1.5	55.00	55.00	1"	5	1.578	F-3	0.024	0.023	0.047		2	1.400	0.0	
18	17.19	2.5	440.0	440.0	2"	5	3.324	11	0.083	0.070	0.152					
19	19.20	1.5	55.00	55.00	1"	5	1.578	F-3	0.024	0.023	0.047		2	1.400	0.0	
20	19.21	2.5	330.0	330.0	2"	5	2.493	11	0.047	0.040	0.086					
21	21.22	1.5	55.00	55.00	1"	5	1.578	F-3	0.024	0.023	0.047		2	1.400	0.0	

1:1 View Network Section

In order to make the network understandable by the program, a specific standardization should be followed, which is more or less the same in all applications. The standardization is easily understood with the following simple example.

Suppose we have the network shown in the adjacent figure. This network comprises several branches (i.e. parts of the network), junction points and terminals (end points). Thus in this network, we have assigned arbitrary numbers to both the junction points (1,2,3) and the hydraulic terminals (4,5,6). Each junction point may be assigned a number or a letter (lower or upper case, e.g. A, d etc) or a combination of letters and numbers (e.g. A2, AB, eZ, 2C etc.). The main logical restriction is that in the starting point is always assigned the number 1. Also, assignment of the same number twice in the same network is not permitted for obvious reasons, with the exception of junction point 1 for which assignment may be repeated as desired (for networks with more than one starting points). After numbering the junction points and terminals according to the above rule and in order to represent the network in the spread sheet, it is enough to give a name to the various sections of the network entered in the first column of the spread sheet. Having in mind that the order of network sections is not important, we fill in the first column with the two junction points of each section (putting a dot in between) so that the sequence of junction points matches the direction of water flow in the pipe. In the above example the sections 1.2, 2.3, 2.6, 3.4 and 3.5 should be filled in (order is arbitrary). In some other columns of the row we fill in a series of data (e.g. length of section, accessories included in the section etc.) which depend on the type of installation while the output resulting from calculations and updating the remaining columns depend also on the particular installation.

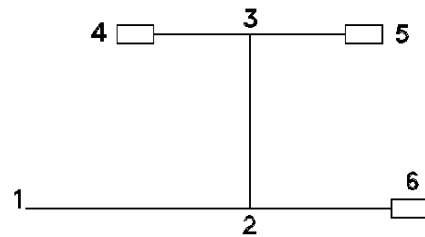

Taking as a reference point the above spread sheet and ignoring initially the filled in values, we can see the **columns heading zone** (every column has its title and units), **the zone for filling in values** with a number of rows (separated with dotted lines for better supervision and clarity) and a **status bar** (at the bottom of the window) where helpful information appears depending on the position we are in the spread sheet. Since the spread sheet contains usually a lot of information and is the core of the calculations in each application, it is particularly useful to have it maximized on screen by clicking on the upper arrow (located at top right of the window), so that the whole computer screen area is utilized.

The next section will familiarize you with the "Calculation Sheet", as the basic functions described therein apply to every application.

The Calculation Sheet provides the user with all the editing functions, which are described below:

First of all, as stated earlier, **in the frames where the Calculation Sheets appear** the user can change the "Font" option for both the calculations zone (so that values appear with the desired size and style) and the headings zone (so that headings are shown to the user satisfaction).

As far as the **headings zone** is concerned, the user has also the possibility to increase or decrease the column width using the mouse: As long as the mouse pointer rests on the vertical line separating two adjacent columns, it takes the form of a double arrow and then by pressing (and keeping pressed) the left mouse button and dragging, the column width is increased or decreased depending on the direction of mouse movement.

The above alternative supervision possibilities available to the user depend on several factors such as the resolution of the graphics card and screen size, and for this reason any possible interventions are left to the user discretion. For that matter, there is also the possibility of "Load Prototype" from the user. Note however, that best supervision results are achieved with higher resolutions and large screens.

Access to the positions of the zone for filling in values is carried out by means of the mouse and the arrow keys of the keyboard. Moving the mouse pointer in the zone for filling in values we can see that in some columns the pointer takes the form of a vertical line (|) while in other columns it takes the form of a prohibitive traffic sign. We cannot modify the values contained in these last columns (because they result from calculations).

If we move the mouse pointer (having the form of a cross) to a cell or small square and click the left mouse button, we'll see that the cell contour (outline) becomes dark and we can fill in a value or modify the cell content. In the same way we can move to any other cell, or using the <Enter> key we move to the next cell below and using the <Tab> key we move to the next cell at the right and so on. Besides, in case the window width is not large enough to accommodate all columns, we can review the entire calculation sheet by manipulating it up-down or left-right using the vertically or horizontally sliding keys (potentiometer like). In addition, when access to a column for filling values is denied, the mouse pointer takes the form of a prohibitive traffic sign. This way, the user is informed that the quantity under examination is a derivative one i.e. resulted automatically from calculations.

The user should keep in mind the following useful commands when **entering values** in the Calculation Sheets of any application:

Deleting cell content: Pressing the key on a cell, the value it contains is deleted, and the cell is blank.

Deleting a row: Pressing the keys <Ctrl>& in combination, the row we are in is deleted.

Inserting a row: Pressing the keys <Ctrl>&<Ins> in combination, a new (blank) row is inserted immediately below the cell we are in.

Moving to the beginning of a row: Pressing the <Home> key we move automatically in the first column of the row we are in.

Moving to the end of a row: Pressing the <End> key we move automatically in the last column of the row we are in.

Moving to the upper part of the sheet (first column-first row): Pressing the keys <Ctrl>&<PgUp> in combination, we automatically move in the first column-first row of the calculation sheet.

Moving to the lower part of the sheet (first column-last row): Pressing the keys <Ctrl>&<PgDn> in combination, we automatically move in the last row of the calculation sheet.

Finally, you can move **from an upper to a lower cell using the <Enter> key** and **from a left cell to a right cell using the <Tab> key**.

In addition, the calculation sheet provides the user with a **set of Spreadsheet Functions, which are available in most windows applications**, such as the Cut-Copy-Paste type of commands of a subset of lines (or even the whole calculation sheet), the row and columns width definition, the font type (as well as font attributes, justification etc) of a selected area, and so on. By selecting a certain area of the sheet (or all of it by "select all") and then pressing the right button of the mouse, a small menu appears on screen, with the relative commands. Another useful command is the Undo/Redo command concerning the calculations. All those editing commands are also applied to other windows. Apart from the copy-paste command, in case we want to repeat a row (typical branch), it is sufficient to fill in the content of the first column, i.e. the section name that will make a copy of the row except for the section name, which remains blank. When the calculation sheet is activated, you will see in the main menu options an additional one namely "Calculation Sheet" with a secondary option "Printing Parameters". Selecting "Printing Parameters" the adjacent dialog box appears from where the user may affect the appearance of the printed Calculation Sheet. Specifically, the user may define a bold outline (frame), a normal outline, or no outline, horizontal and/or vertical lines, as well as a raster for the titles (headings) of the spreadsheet with the desired shading of tints (using the sliding key).

3.2 Main Menu

If you want the Fire Fighting System application to be executed, point with the mouse and double click on the relevant icon, and the main menu window will appear:

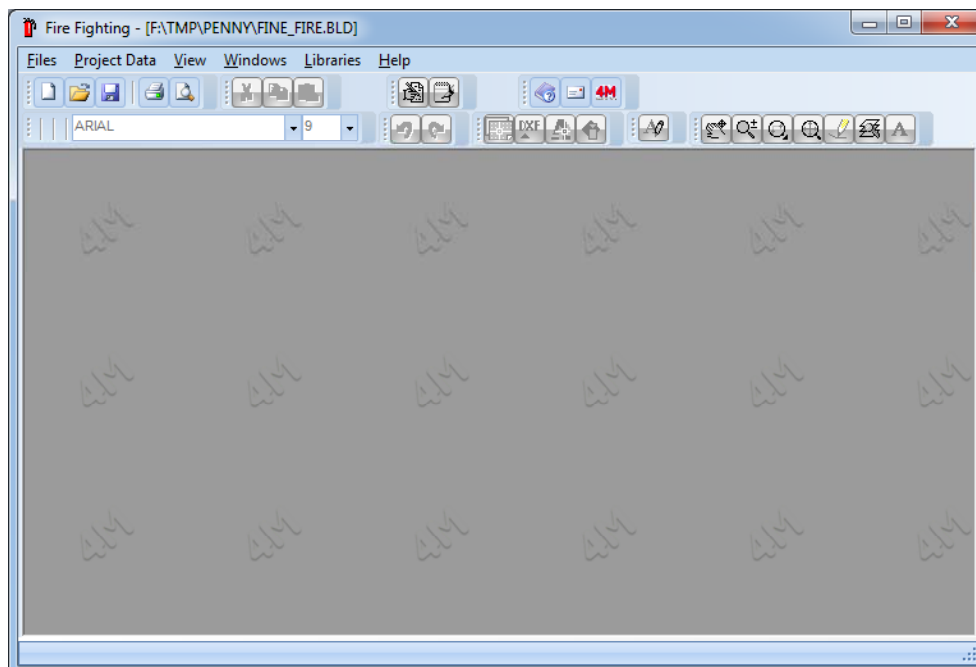

As you can see, the basic menu options are divided into the groups **"Files"**, **"Project Data"**, **"View"**, **"Windows"**, **"Libraries"** and **"Help"**, which are described below along with their secondary options.

3.3 Files

The "Files" option includes the usual file management options according to the windows standards:

New project: Type a name for the new project you want to be saved in a file.

Project selection: A window appears where you can select the desired (existing) project file and load it.

Caution! *If neither a new nor an existing project is selected, the program automatically considers that the UNNAMED project is active. If you add new data to the UNNAMED project and you want to save it with a different name, select "Save as" and type the new project name.*

Update from Drawing: In the case of co-operation with the FINE package, the project calculation sheets are updated with the drawing data.

Caution! *If the option "Update from Drawing" is selected, without previously opening a project and inserting rooms in the ground-plans using the FINE package, any existing data in the calculation sheets will be replaced with blanks.*

Save Project: The project you are currently working on is saved to the hard disc (with the previously given name).

Save Project as: The project you are currently working on is saved in a different file with a new name.

Load Prototype: The saved prototype appears on the screen.

Save as Prototype: The form, which has been created by the user and is displayed on the screen when this option is selected, is saved as a Prototype.

Printing Prototypes: The printing prototype management window is activated.

Printing: The project issue is printed according to the selected options in "Printing Contents" and "Printing Parameters" as well as according to the print preview output.

Printing Contents: You can select the Fire Fighting System project items you want to be printed.

Printing Parameters: The desired printing parameters can be selected in this window.

Print Preview: The complete project issue appears on the screen, exactly as it will be printed, page to page.

Export to RTF: An rtf file, containing the project items, is created (within the project directory, with the name PYRO.RTF).

Link to WORD: A .doc file, containing the project items, is created (within the project directory, with the name PYRO.DOC). At the same time, the MS-Word application is activated (if it is installed in your PC).

Link to 4M editor: An rtf file, containing the project items, is created (within the project directory, with the name PYRO.RTF). At the same time, the 4M text editor is activated for further editing.

Link to Excel: An xls file, containing the project items, is created (within the project directory, with the name PYRO.xls).

Export to PDF: A pdf file, containing the project items, is created (within the project directory, with the name PYRO.pdf).

Exit: Exit from the application.

3.4 Project Data

The basic project data are divided into **Project Info** (project headings) and **Network** data. Project info refer to titles and headings related to the project identity, while the "Network Options" window refers to the general network data that you should specify and are related to:

Water temperature (°C): The water temperature value is filled in and the relevant viscosity is taken automatically into consideration for the calculations.

Type of building: Select the type of the building from the list that opens if you press the key in the field and the relevant coincidence curve is taken into account.

Primary pipe type: With the key <F11> or by pressing the key in this field, you can select from the window that appears, the primary pipe type which shall be used in the project (e.g. steel pipe).

Primary pipe C Value: This option is visible if one of the methods Fully calculated systems NFPA 13, Fully calculated systems EN 12845, Fully calculated systems AS 2118, Fully calculated systems BS 9251, Fully calculated systems FM Global, or Fully calculated systems CEA 4001 has been selected. The C value of the primary pipe is entered automatically depending on the pipe type selected, but you can easily modify it.

Primary pipe Roughness factor: This option is visible if one of the methods NFPA Ordinary Hazard Pipe Schedule or Hydraulic Calculations has been selected. In this field the roughness factor of the selected primary pipe appears automatically but if you want, you can modify it (in µm).

Water Temperature (°C)	10
Type of Building	Industry - Store
Primary Pipe Type	Steel Pipes (flexible)
Primary pipe C Value	120
Secondary Pipe Type	Steel Pipes (flexible)
Secondary pipe C Value	120
Maximum designed Water Velocity (m/s)	5
Maximum velocity for the stabilized flow condition at the demand point (m/s)	10
Hazard classification	Ordinary Hazard
Calculation Method	Fully calculated Systems EN 12845
Import data from the Vertical Diagram	<input type="checkbox"/>
Calculate Automatically	<input checked="" type="checkbox"/>

Secondary pipe type: With the key <F11> or by pressing the key in this field, you can select from the window that appears, the secondary pipe type which shall be used in the project (in case two types of pipes are used).

Secondary pipe C Value: This option is visible if one of the methods Fully calculated systems NFPA 13, Fully calculated systems EN 12845, Fully calculated systems AS 2118, Fully calculated systems BS 9251, Fully calculated systems FM Global, or Fully calculated systems CEA 4001 has been selected. The C value of the secondary pipe is entered automatically depending on the pipe type selected, but you can easily modify it.

Secondary pipe Roughness factor: This option is visible if one of the methods NFPA Ordinary Hazard Pipe Schedule or Hydraulic Calculations has been selected. In this field the roughness factor of the selected secondary pipe appears automatically but if you want, you can modify it (in μm).

Maximum designed water velocity (m/s): Enter the maximum designed water velocity. In this way, the pipe with the smallest possible cross-section, for which the velocity does not exceed this value, shall be selected. You can modify the maximum velocity either from here as a whole (and it shall be applicable in every part of the network) or within the calculations sheet for every network section in the “Max velocity” column.

Maximum velocity for the stabilized flow condition at the demand point (m/s): Enter the maximum velocity for the stabilized flow condition at the demand point. This value will be used in the network checking of the sections’ velocities.

Hazard classification: Select the hazard classification among “Light”, “Ordinary” and “High”. This is for reference on reports only.

Calculation method: You can choose among several calculation methods: NFPA Ordinary Hazard Pipe Schedule, Hydraulic Calculations, Fully calculated systems NFPA 13, Fully calculated systems EN 12845, Fully calculated systems AS 2118, Fully calculated systems BS 9251, Fully calculated systems FM Global, or Fully calculated systems CEA 4001.

Import data from the Vertical Diagram: This option enables you to draw the vertical chart firstly with the aid of an expert system and thereafter to transfer the data in the calculation sheet (it is used in case you do not want to generate automatically the vertical diagram from FINE FIRE). If you check this box, the option “Draw vertical diagram” appears in the program menu and you can use it in order to draw the vertical diagram.

Calculate automatically: In big projects where the calculations are time consuming, you can uncheck this field, make any changes you want in the network and then press the “Calculations” button to run the calculations.

3.5 Draw Vertical Diagram

This option includes the two secondary options “Vertical Diagram Creation” and “Update from vertical Diagram”, which are explained in the following paragraphs.

3.5.1 Vertical Diagram Creation

This option has the following secondary options:

1. Diagram type

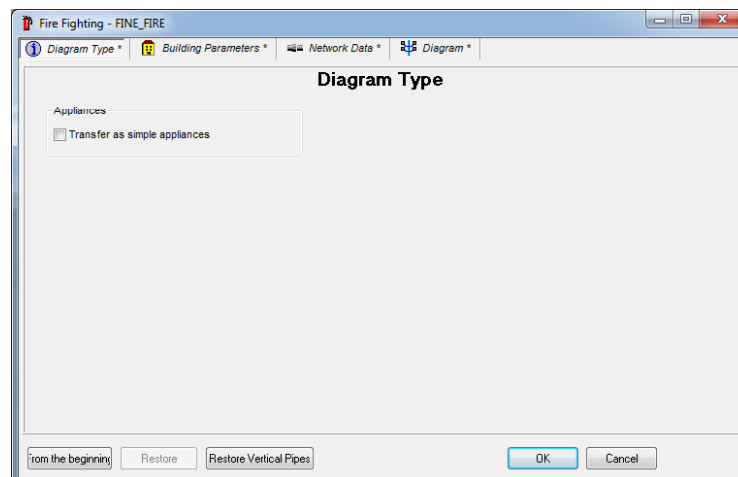

- **Appliances > Transfer as simple appliances**

It is specified whether each appliance is defined separately in the vertical diagram or if it will be integrated in a receptor group. In case that the check box is checked, the network is analyzed thoroughly in nodes.

2. Building parameters

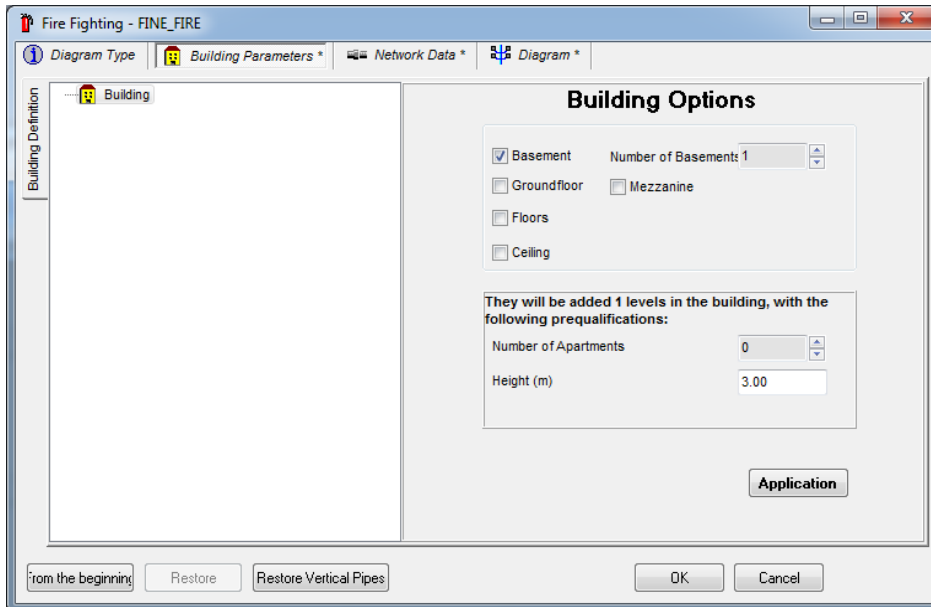

If you select the *Building* in the upper left part of the screen, the building data will appear.

The topology of the building as well as the layout of the installation network in it is included in the building parameters.

Here the levels (floors), which constitute the building, are defined. In “Building options” the levels of the buildings are checked. In particular, if you select the Basement and the Floors, an additional field will appear where you fill in their number. You can also define the number of the apartments in each floor as well as the height of each floor.

After you have defined the building data, press the key “Apply” and the building will appear in the left column in a tree form with an icon in front of it that shows the floor type.

Working with levels

If you click with the left mouse key on the level name, the options “Level Name”, “Level Height (m)” and “Number of Apartments” appear on the right side. You can enter the fields “Level Name” and “Level Height (m)” and edit the level data.

If you double click with the left mouse key on the level name, the floor topology with the apartments will appear in tree form.

If you click with the right mouse key on the floor name, a menu with the following options will appear:

- **New apartment entry:** You can insert a new apartment besides the ones that are defined so far.

- **Copy of floor:** Copies in the PC memory (clipboard) the floor network in order to paste (copy) it later on a different floor.

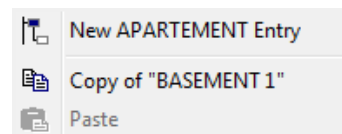

- **Paste:** Pastes the network data that are saved in the clipboard to the selected floor. The data that are already entered in the floor shall be overwritten by the new data.

Working with apartments

If you double click on the floor the apartments will appear and in the right side will appear the option “Insert Space with water supply”, where a list with various system types will be shown. If you double click on each system, its drawing will appear underneath it. If you double click on the desired system, this will be transferred automatically in the apartment selected in the left column. In the same way you can add more systems in the same apartment or in different.

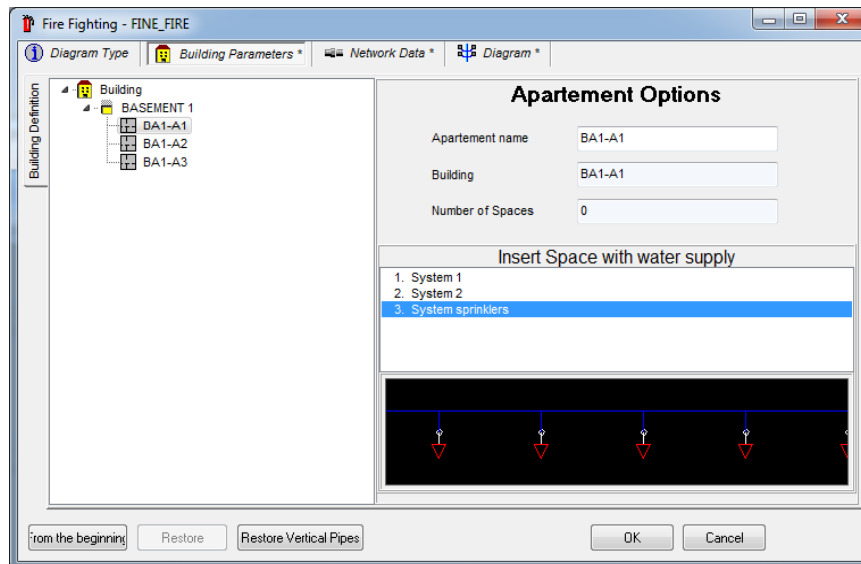

If you right click with your mouse on an apartment, the list shown in the next window will appear, with which you can manage the systems:

- The command “Insert new system“.
- The commands “Delete of” deletes the selected system.
- The command “Copy of” copies the selected system.

3. Network data

In the option connections you can see the network structure from the Fire Fighting until each apartment.

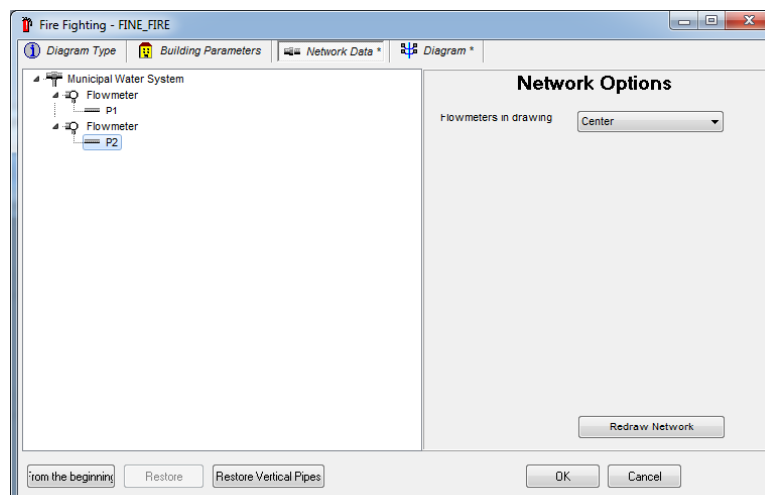

In this option, you can manage the Fire Fighting systems. At first, there is a separate Fire Fighting system for every apartment. If for example, there are two apartments in the building with common ownership, which are located in different floors, then you can

transfer the Fire Fighting from a column to a different one, to delete a column or a certain flow gauge. This is achieved by right clicking on an element. Depending on the "tree" element on the left side of the window that you right click, a menu appears which enables you to move or delete or even add an element. Hence, you are able to modify the network as it is desired.

4. Diagram

With this option, the vertical diagram of the previously mentioned installation appears. Moreover, you can change the colors that appear in the diagram.

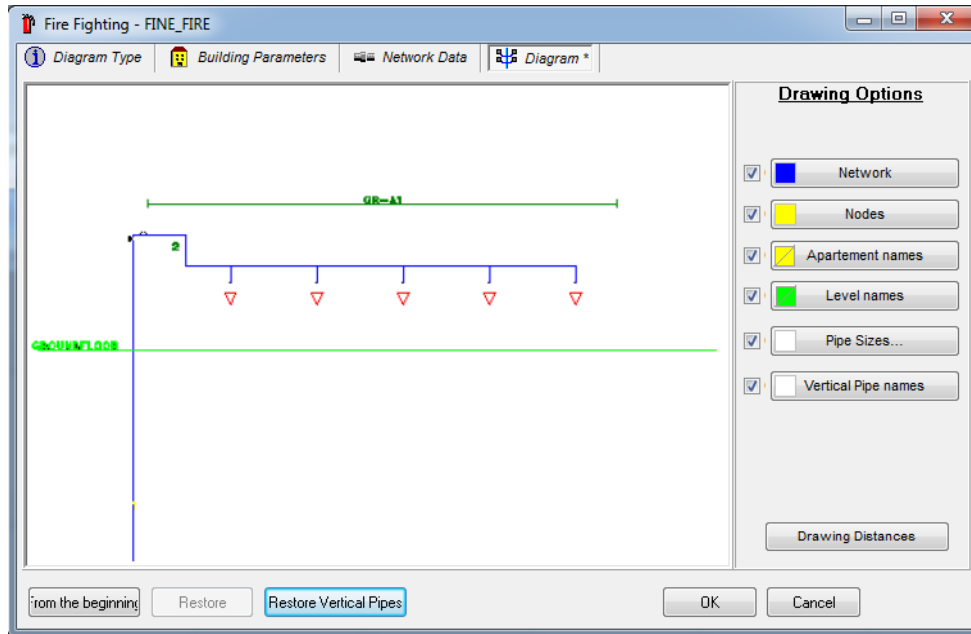

3.5.2 Update from vertical diagram

This command is used to transfer the network data of the vertical diagram in the "Calculation sheet".

3.6 View

This option includes the secondary option "Toolbars" and follows in general the windows standards.



3.7 Windows

The option "Windows" includes a series of calculation and result windows, in which the detailed project calculations are presented. The main window which comprises the core of the application calculations is the Calculation Sheet, and is described in the following paragraphs.

3.7.1 Cover Page

The "Cover page" window is the first printed page of the project and if the user wants, he can easily change it or create his own.



To load or create a different cover page, in the program menu go to Cover page > Prototypes, select the prototype you want and press "Load". If you want to save the cover page you made and use it in other projects, in the same window enter a name and a number (e.g. 02 Simple Alignment) and choose "Save as".

If you want to edit the cover page, press the “Edit text” button , make the changes you want and then press it again in order to save them. The same applies if you want to edit the prototype cover page and in this case you press the “Edit prototype” button .

 **Note:** The cover page file is stored in FINE14_FIRE\CALC\PYRO\, named PYROCV01.RTF

3.7.2 Assumptions

The text of the project general assumptions, which may be included in the printed project as long as it is selected in "Printing Contents", is stated. If the option “Assumptions” is selected, you can load a different prototype or create your own from the program menu Assumptions > Prototypes. To do this, go to Assumptions > Prototypes, select the prototype you want and press “Load”. If you want to save the assumptions you made and use it in other projects, in the same window enter a name and a number (e.g. 02 Simple Alignment) and choose “Save as”.

If you want to edit the assumptions, press the “Edit text” button , make the changes you want and then press it again in order to save them. The same applies if you want to edit the prototype assumptions page and in this case you press the “Edit prototype” button .

 **Note:** The assumptions file is stored in FINE14_FIRE\CALC\PYRO\ , named PYROPR01.RTF

3.7.3 Systems of Receptors

Here the Receptor Systems that are used in the specific project are presented and analyzed in the receptors constituting them.

3.7.4 Receptors Legend

The receptors used in the project are presented.

3.7.5 Calculation Sheet

The Calculation Sheet of the Fire Fighting System is the core of the calculations and conforms to the general rules of the Network Calculation Sheets, which are described in the first section. Therefore, each row of this sheet corresponds to a different network section while each column refers to the data that will be filled-in or will ensue automatically during the procedure of data completing. Help instructions concerning data entering appear at the bottom of the screen (status bar). In each row, the fields of the first column, which refer to section designations, should be filled-in first of all.

The method for the network standardization is based exactly on the standardization rules that were explained earlier. Here is a short description of the columns of the calculation sheet:

Network Section	Pipe Length m	Type of Receptor	Receptor Capacity (l/min)	Peak Capacity (l/min)	Desired Pipe Size mm	Pipe Size mm	Max Velocity m/s	Water Velocity m/s	Type of Fittings	Fittings friction drop (bar)	Pipes friction drop (bar)	Total Friction Loss (bar)	Circuit Polar Angle	Receptors Group	Required Pressure of Receptor (bar)	D.D. (bar)
1	1.2		6560	3810	4"	5	7.292	F-1	0.372	0.066	0.438					
2	2.3		710.0	380.0	2"	5	2.871	F-2	0.189	0.182	0.371					
3	3.4	2	380.0	380.0	2"	5	2.871	F-3	0.078	0.069	0.147		5	4.500	0.0	
4	3.5		330.0	330.0	2"	5	2.493	F-4	0.059	0.062	0.121					
5	5.6	1	55.00	55.00	1"	5	1.578	F-3	0.024	0.023	0.047		1	1.400	0.0	
6	5.7		220.0	220.0	1.5"	5	2.672	11	0.054	0.062	0.115					
7	7.8	1	55.00	55.00	1"	5	1.578	F-3	0.024	0.023	0.047		1	1.400	0.0	
8	7.9		110.0	110.0	1"	5	3.155	8	0.149	0.149	0.298					
9	9.10	1	55.00	55.00	1"	5	1.578	F-3	0.024	0.023	0.047		1	1.400	0.0	
10	9.11		55.00	55.00	1"	5	1.578	F-3	0.024	0.020	0.044		1	1.400	0.0	
11	7.12	1	55.00	55.00	1"	5	1.578	F-3	0.024	0.020	0.044		1	1.400	0.0	
12	5.13	1	55.00	55.00	1"	5	1.578	F-3	0.024	0.020	0.044		1	1.400	0.0	
13	2.14		1040	860.0	2.5"	5	2.959	F-2	0.201	0.256	0.457					
14	14.15		660.0	660.0	2.5"	5	2.959	F-5	0.101	0.062	0.163					
15	15.16	1	55.00	55.00	1"	5	1.578	F-3	0.024	0.023	0.047		2	1.400	0.0	
16	15.17		550.0	550.0	2"	5	4.155	11	0.129	0.108	0.237					
17	17.18	1	55.00	55.00	1"	5	1.578	F-3	0.024	0.023	0.047		2	1.400	0.0	
18	17.19		440.0	440.0	2"	5	3.324	11	0.083	0.070	0.152					
19	19.20	1	55.00	55.00	1"	5	1.578	F-3	0.024	0.023	0.047		2	1.400	0.0	
20	19.21		330.0	330.0	2"	5	2.493	11	0.047	0.040	0.086					
21	21.22	1	55.00	55.00	1"	5	1.578	F-3	0.024	0.023	0.047		2	1.400	0.0	

1. Network section: In the rows of the first column you fill-in all the network sections (one section in each row) one by one. The sections are defined by their end nodes. You may assign a number (from 1 to 9999) or a letter (lower or upper case, e.g. A2, AB, 3c, Aa etc.) to each node. The basic restriction in numbering is that number 1 is always assigned to the point that is connected to the gauge. Except the number "1", the same number should not appear in the network twice. After the numbering, you can enter in the calculation sheet all the sections independently one by one (the sequence of the sections is not important), by filling-in the first column:

In the case of typical (similar) sections it is possible to recall them (with their name from the first column) in order to automatically transfer them.

2. Pipe length: You must enter the pipe length in (m) in every section between two nodes (e.g. section 2.3).

3. Type of receptor: If there is a receptor (appliance) at the specific network section, that is to say if the section ends up to a receptor, you can select it from the library with the Fire Fighting network appliances, after pressing the key **F11** or by pressing the key inside the field in this column. A window will appear with the list of the appliances. In this window, the type of the appliance (hydraulic receptor) is defined when a unit is filled-in in the last column, in the row that corresponds to the receptor, and the key "enter" is pressed after that in order to validate the data entered. By pressing "OK" you can return to the calculation sheet where you can notice that the order number of the receptor is filled-in. Alternatively, except defining only one receptor, you can also define a receptor group (receptor system) with up to 10 different types of receptors in each section. Since you are working with receptor groups, the program enables the user to define an order number of the hydraulic receptors system *i* in the upper part, and the relevant receptor system appears in the sixth column of the Calculation Sheet with the form S-*i*, where *i* represents the order number of the defined System.

No	Name	In.Dia.	Pmf	Qr
1	Sprinkler		1.4	60
2	Sprinkler		1.4	80
3	Sprinkler		1.4	100
4	Fire hose cabir 50		4.5	100
5	Fire hose cabir 50		4.5	200

With this feature you avoid filling-in again the same appliances, since you can fill-in directly the order number of the System. The method with receptor systems is indicated in the case of very large installations, where the cases are grouped in a few systems and the data volume is radically decreased in the calculation sheet.

4. Area of coverage per sprinkler (m²): This column is visible only when one of the methods Fully calculated systems NFPA 13, Fully calculated systems EN 12845, Fully calculated systems AS 2118, Fully calculated systems BS 9251, Fully calculated systems FM Global, or Fully calculated systems CEA 4001 has been selected. This field shows the area that covers the selected receptor. When you select a receptor and this field is blank, it will be automatically filled in with the maximum area of the receptor from the library.

5. Design density (mm/min): This column is visible only when one of the methods Fully calculated systems NFPA 13, Fully calculated systems EN 12845, Fully calculated systems AS 2118, Fully calculated systems BS 9251, Fully calculated systems FM Global, or Fully calculated systems CEA 4001 has been selected. This field shows the design density of the selected receptor. When you select a receptor and this field is blank, it will be automatically filled in with the design density of the receptor from the library.

6. Receptor flow (l/min): The receptor capacity Q_R , or in general the network section capacity (theoretical sum of the capacities if all the receptors work at the same time) is automatically calculated. The program calculates automatically the capacity for the intermediate sections based on the capacity of the receptors that are supplied from this section.

7. Peak capacity (l/min): The peak capacity Q_s is calculated based on the total capacity of the previous column. The peak capacity is calculated from the relevant peak curve that depends on the "Type of building" which is defined in the "Network" window.

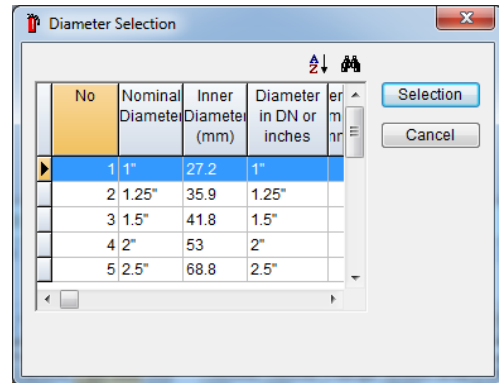

8. Desired pipe size (mm): From this column you can select a different diameter from the one that is calculated by the program (and is shown in the next column). If you press **F11** or the key in the field, the list with the diameters of the selected in the "Network" window pipe type is shown.

With the option "Select" you can select the desirable diameter, and you can see the effects of your choice in the rest of the network parameters (e.g. velocity, friction values etc). If you press in the relevant component of the calculation sheet you can delete the selected diameter, and the program will calculate again the diameter.

9. Pipe size (mm): In this column, the pipe diameter of the network section is shown, as the program calculates it.

10. Maximum velocity (m/s): In this column the velocity limit that is defined in the "Network" window is shown and you can modify it if you want for the particular network section. Keep in mind that, if you change later the general limit in the "Network" this will not affect the modified values, but only the initial ones (the ones that have the same value with the "Maximum network velocity" which is defined in the "Network").

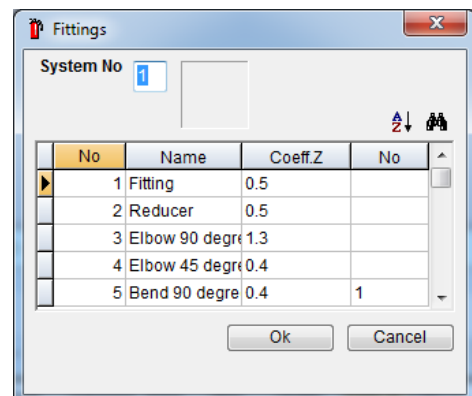

11. Water velocity (m/s): The water velocity as it is calculated in the specific network section is shown here.

12. Type of fittings: This column refers to the type of fittings (elbows, tee sections, valves etc.) that appear in the network section. If you want to fill in the components in detail, press **F11** or the key in the field in this column, and the window with the list of the Fire Fighting system components from the

relevant library will appear. If only one component exists, this is defined by writing the number 1 in the last column, in the row that corresponds to the component. By pressing "OK" you can return to the calculations sheet where you can notice that the order number of the defined component is filled in.

For more than one component you can fill in correspondingly the last column of the table with components, giving also the quantities of each component (up to 10 different types of components per section). In the case that you have more than one component, the indication F- appears which means in general "Fittings". If, in the upper part of the component table, you define a component system number a, in this column the indication F-a will appear. In this way you can group the components and also avoid filling in the same groups (systems), since in the "Type of fittings" column where the components are defined you can fill in directly the system number.

Note: *In the methods Fully calculated systems NFPA 13, Fully calculated systems EN 12845, Fully calculated systems AS 2118, Fully calculated systems BS 9251, Fully calculated systems FM Global and Fully calculated systems CEA 4001 the program calculates automatically the "Equivalent length" of the fittings in each pipe section. To see it, you can go to Files > Printing contents and check the "Piping calculations".*

13. Fittings friction drop (bar): The calculated friction value of the fittings in the specific network section is shown here.

14. Pipes friction drop (bar): The calculated friction value for the piping in the specific network section is shown here. This friction is calculated from the water flow in the said section, based on hydraulic calculations.

15. Total friction loss (bar): The sum of the Friction of Components and the Friction of Piping is shown in this column.

Note: *The velocity and the friction in each section have been calculated using the design flow of the sprinkler.*

Following you will see the columns "Circuit Polar angle", "Receptors group", "Required discharge pressure", "Pressure Difference (DP) due to different height", "Pipe design length" and "Type of pipe". These columns can be filled-in directly in the relevant columns or from an additional window, which appears if you press the key F12 in any column or if you press the right mouse button and select from the list, "Options". The use of these items is explained below:

16. Circuit Polar Angle: It is necessary to fill in the polar angle of each network section only in case that you want to draw the vertical diagram directly from the calculation sheet and not generate it automatically from FINE FIRE. The vertical diagram that is drawn takes into account the length and the polar angle (in relation to the horizontal axis) of each section.

17. Receptors Group: If you want to set several receptors into the same group, in this column the number of the group will be shown. Usually, a group consists of a number of sprinklers, or a fire hose cabinet plus some sprinklers.

In case a sprinkler belongs to more than one group, type the number of the groups as e.g. "1,3". The calculations for each group are made using the initial design flow of the sprinklers.

Note: *The "piping calculations" are printed for each sprinkler group separately.*

18. Required discharge pressure (bar): Here you have to fill in the required pressure of the receptor, which must be at least equal to its minimum discharge pressure. The above mentioned pressure is filled in only in case that you have given a direct flow or a receptor

system, since in the case that you select a receptor from the library the discharge pressure is filled in automatically.

19. Pressure Difference (DP) due to different height (bar): In this column you fill in the Pressure Difference (DP) due to the receptor level elevation (positive or negative values). This is the elevation from the supply point to the receptor. **This is provided only in the sections with receptors and not in intermediate sections.**

20. Pipe design length (m): Sometimes, when drawing a vertical diagram, you may design very short or very long sections. For that reason, in this column you can define an arbitrary pipe length, which however will affect only the way that the pipes are depicted in the drawing. Regardless of the length that you define in this field, the program shall write the **real pipe length** on the drawing. It should be pointed out that in case you do not fill in this field, the program shall draw the vertical diagram based on the column "Pipe length" of the "Calculation Sheet".

21. Type of pipe: Select the type of the pipe between primary and secondary (you define the pipe materials in Project Data > Network window).

Fixed column: Moreover, through the "Calculation Sheet" menu in the upper part of the window, you can select the number of "Fixed Columns" so that these columns of the calculation sheet "freeze" on the screen. In this way, as you fill in the fields of the sheet and you are "led" towards the right, you will know exactly on which network section you are working on anytime. When the "Fixed Column" option is active, a yellow point (pin) appears at the bottom of the "frozen" field.

3.7.6 Fire Pump Calculation

In the "Fire pump calculation" window you can select the fire pump and run an NPSH (Net Positive Suction Head) check.

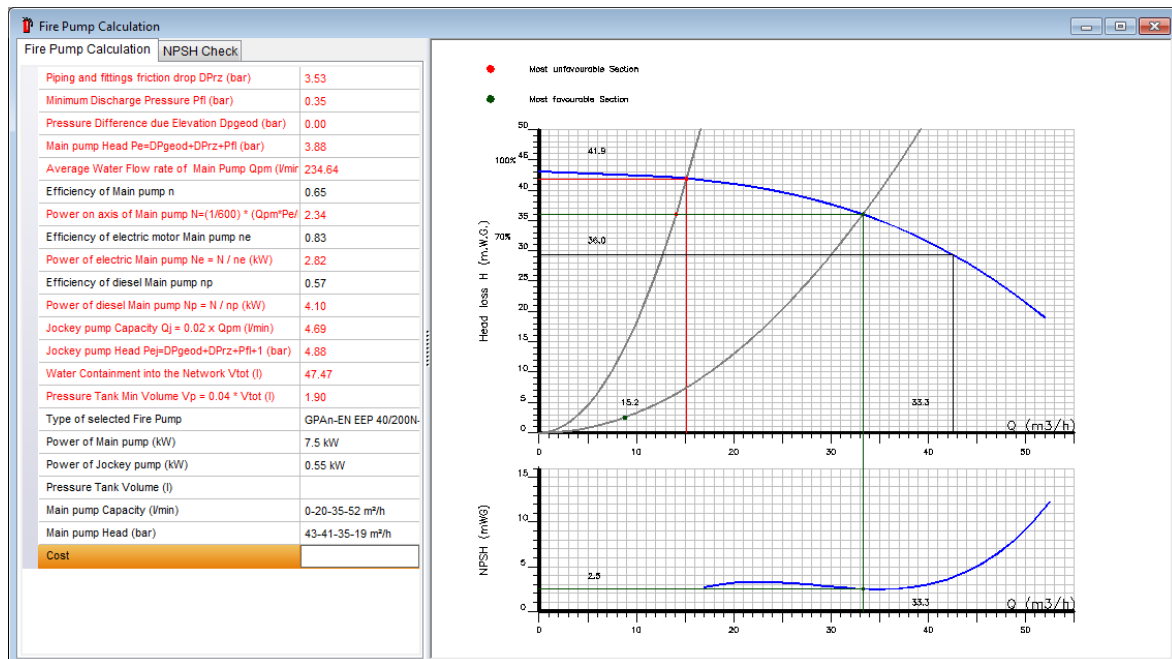

Fire Pump Calculation

In this tab you can calculate and select the type of the fire pump. The results that appear in red color have been automatically calculated and you only have to fill in the "Efficiency of main pump", "Efficiency of electric motor main pump" and "Efficiency of diesel main pump". When these fields have been completed, the minimum volume of the pressure tank is calculated and you can select in the "Type of selected fire pump" field the

appropriate fire pump from the library. When you select the fire pump, you can see on the right side of the window its pump curve.

When one of the methods Fully calculated systems NFPA 13, Fully calculated systems EN 12845, Fully calculated systems AS 2118, Fully calculated systems BS 9251, Fully calculated systems FM Global or Fully calculated systems CEA 4001 has been selected, the most unfavourable and most favourable areas are depicted on the curve, along with the design pump flow and the maximum pump flow.

Note:

- For the calculation of the fire pump all the sprinkler groups have been taken into account with their calculated flows.

NPSH Check

This option is not available for the “NFPA Ordinary Hazard pipe schedule” and the “Hydraulic Calculations” methods.

- **Type of suction head:** Select the type of the suction head between “Positive head” conditions and “Suction lift” conditions.
- **Pipe type:** With the key <F11> or by pressing the key in this field, you can select from the window that appears, the pipe type that shall be connected to the pump suction.
- **Pipe length:** Enter the length of the pipe that shall be connected to the pump suction (in m).
- **Equivalent length of fittings:** Select the type of fittings that are used. To fill in the components, press F11 or the key in the field and the window with the list of the fittings will appear. To select a fitting, write the number “1” in the last column in the row that corresponds to the component. By pressing “OK” the program calculates automatically the “equivalent length” (in m).
- **Desired pipe size:** If you want a different pipe size from the calculated, you can select it from the list that appears when pressing the key in this field.
- **Static pressure in the fluid:** Enter the static pressure in the fluid Pstat (in mmH₂O).
- **Fluid vapour pressure:** Select a fluid vapour pressure from the table that opens when pressing the key in this field.

When the fields have been filled in, you can see on the right side of the window the NPSH curve (right below the pump curve) and the program checks whether the pump can work at its maximum operating point at all levels of the water supply $NPSH_a - NPSH_r \geq 1\text{m}$.

3.7.7 Water Tank Calculation

In this window you can calculate the size of the water tank, which is necessary for the installation.

3.7.8 Network Drawing

The numbered network drawing is shown on the screen, provided that polar coordinates have been inserted in every network branch (see calculation sheet).

3.7.9 Vertical diagram

If you want to create a vertical diagram using the calculation sheet (and not automatically, using FINE FIRE program), the above option creates the vertical diagram provided that the polar coordinates have been inserted in every network section.

It is pointed out that it is possible to load a drawing for the engine room from the menu Vertical diagram > Select side for machine room.

3.7.10 Sections Friction drop

In this window you can view the total frictions in all sections starting from the gauge and ending in each terminal node. Moreover, for more convenience, the most unfavourable network section appears in the bottom of the window.

When one of the methods Fully calculated systems NFPA 13, Fully calculated systems EN 12845, Fully calculated systems AS 2118, Fully calculated systems BS 9251, Fully calculated systems FM Global or Fully calculated systems CEA 4001 has been selected, you can view the total frictions for the stabilized flow condition for each sprinkler group separately. You can also see in the window the most favourable and unfavourable groups with their required pressures, their capacities and the sections with the highest pressure drop.

3.7.11 Network checking

In this window, the program checks for any pipe sections in the stabilized flow condition that their velocity exceeds the maximum or they have no flow. The results are presented under each sprinkler group.

Note: This option is not available for the “NFPA Ordinary Hazard pipe schedule” and the “Hydraulic Calculations” methods.

3.7.12 Four sprinklers under consideration

This window is shown only when the calculation method includes the calculation of the 4 worst sprinklers of the network.

When you have been transferred to the calculations from the drawing, the program finds automatically the 4 worst and best sprinklers under consideration; it shows the specified density of each group (best and worst) and calculates the density over the 4 sprinklers. With the exception of the first row in each table which shows the worst sprinkler of the group, you can edit the rest by pressing the selection button in the row or even delete a sprinkler from the group. If you edit the rows and want to return to the information transferred from the drawing, select the “Update from drawing” button.

Note: This option is not available for the “NFPA Ordinary Hazard Pipe Schedule”, the “Hydraulic Calculations”, the “Fully calculated systems NFPA 13” and the “Fully calculated systems FM Global” methods.

3.7.13 Bill of Materials - Costing

The bill of materials-costing results regarding the specific project is presented. You can edit the bill of materials-cost estimation sheet, modify the costs or quantities, insert discounts and add jobs or materials followed by their costs and quantities.



3.7.14 Detailed Bill of Materials

The exact quantity of the materials that have been used in the specific installation (i.e. pipes, number of sprinklers etc.) is being generated by the program in an editable table form.

3.7.15 Technical Description

The window “Technical Description” supports the creation of the project technical description. You can select among various technical description prototypes and text editing styles. To load a different technical description, in the program menu go to Technical description > Prototypes, select the prototype you want and press “Load”. If you

want to save the technical description you made so as to use it again, in the same window enter a name and a number (e.g. 02 Sprinkler technical description) and choose “Save as”.



If you want to edit the technical description, press the “Edit text” button , make the changes you want and then press it again in order to save them. The same applies if you want to edit the prototype technical descriptions page and in this case you press the “Edit prototype” button .

 **Note:** The technical description file is stored in FINE14_FIRE\CALC\PYRO\ , named PYROTP01.RTF

3.8 Libraries

The Fire Fighting Libraries comprise the following material categories, with their respective features:

- **Fittings**, with specified characteristics (coefficient z, cost)
- **Pipes** (pipe types) with a given roughness, standardization (nominal, internal diameter) and material.
- **Receptors** (connection pipe size, water flow, cost etc.).
- **Fire pumps**, with all their features and their performance.
- **System of receptors:** The library is fitted with a tool that allows the design of new receptor systems as well as the modification of the existing ones.
- **Offer libraries:** You can add your own offer libraries.

In any of the above libraries, you can easily change or add your own information. In order to add a new fitting, receptor etc. press the “Append record” button  at the bottom of the page. The program automatically creates a new blank row where you add the information you want and after pressing the “Post edit” button  you press OK. In this way, you can use your own libraries in every project you are working.

3.9 Help

In this option you will find the instructions of the program, according to the windows standards.

3.10 Examples

In this chapter two step-by-step examples are presented, which will help you understand in practice the basics of drawing in FINE FIRE. These simple examples aim mainly at helping you start drawing building entities (walls, openings etc.) along with the fire fighting network. More specifically:

- *Example 1*, describes the steps of drawing a simple level (optional).
- *Example 2*, describes the steps of drawing a simple fire fighting network, proceeding to the calculations and generating the necessary drawings.



Important: *It isn't necessary to draw the levels of the building with walls, openings etc. in order to calculate the fire fighting network. If you already have 2D architectural drawings of the levels you can insert them and place on them the receptors, the pipes etc. Nevertheless, if you do not have architectural drawings, it will be more helpful to draw the walls etc. so as to be able to design the network more accurately.*

Apart from the following examples, you can watch the same steps (and much more) in the videos you will find in <http://www.4msa.com/FineFireENG.html>.

3.10.1. Building design example

In this example, the drawing of the adjacent simple building is described, including the steps from the beginning (creating a new project) to the end so that you can easily understand the function of FINE FIRE in practice.

For this example, we will import two architectural plan views that have been designed in AutoCAD although you can start drawing from scratch. If you have already designed the building in IDEA Architecture 14, you can skip this example.

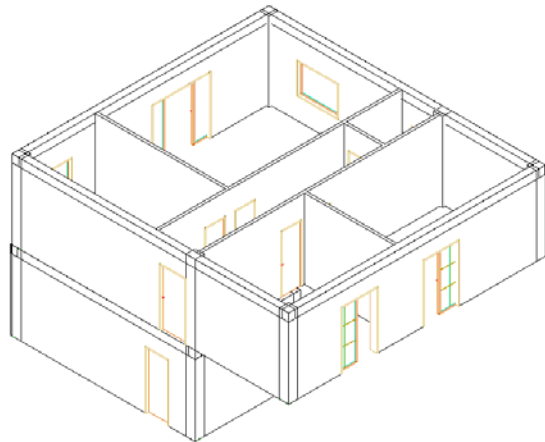

1. From FILES menu, we select “New project”, type “Example_1” and press “Accept”.
2. From AutoBLD menu, we select “Building definition”, define as level 1 the “Basement” in elevation “-3” and from “File” we load its architectural drawing. Before we define the second level, we press “New” (so as to save the changes) and we follow the same steps for the second level, as it is shown below.

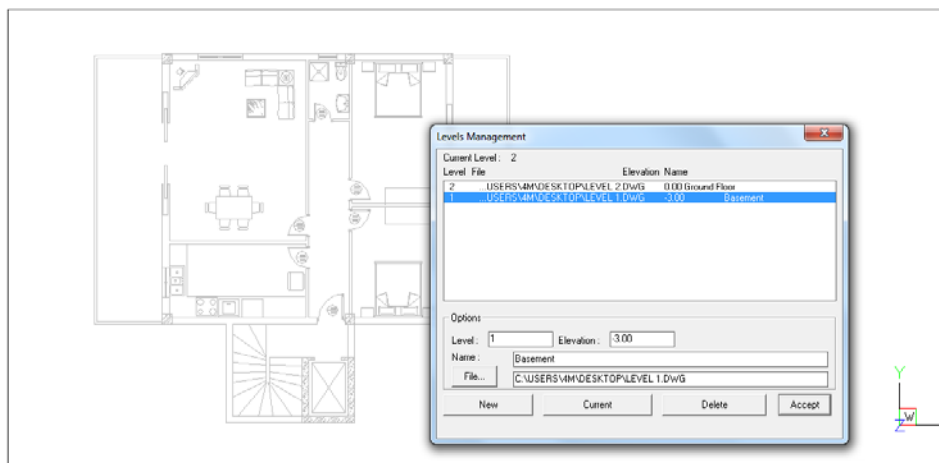

When we finish, we press once again “New” and then “Accept” and automatically we defined the two levels with their architectural drawings.

3. Before we start drawing, we “Lock” the architectural drawings from the layers list on the left by pressing the “Lock” symbol as it is shown below. The name of the architectural drawing will be BASE_FLOO1_XREF for the first level, BASE_FLOO2_XREF for the second level etc.

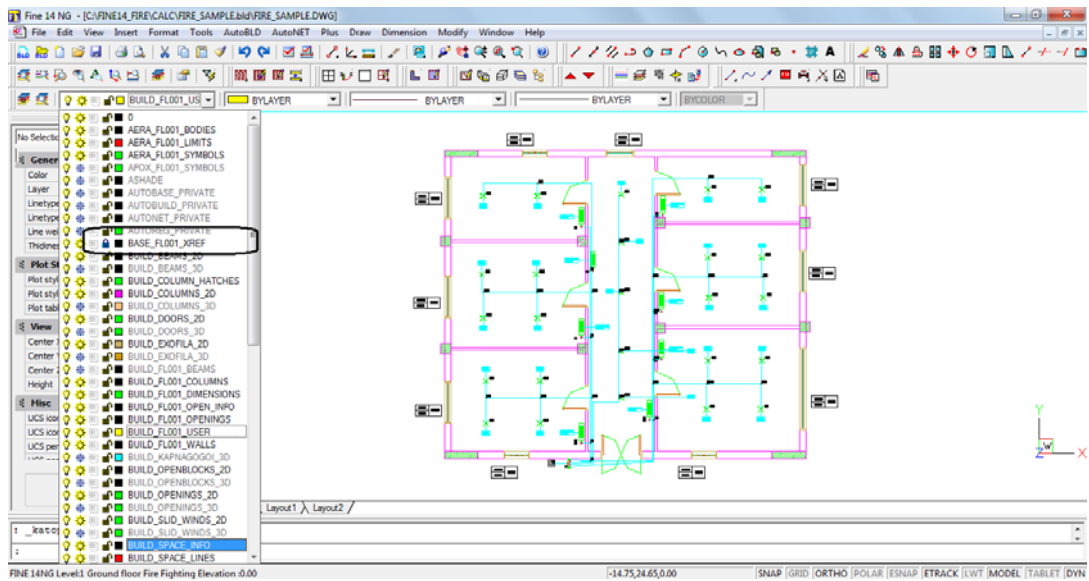

4. From AutoBLD, we select Walls > Outer wall and in the properties window we define the height (3 m in our example) and the width (0.25 m) of the wall, the height and the width of the column (it will be automatically designed along with the wall), its type etc.

When we finish, we press “Accept” and we design the wall by defining three points:

- First, we click on the beginning of the wall (where the left red spot is, in the following image)
- Then, we click on the end of the wall (where the upper right red spot is) and
- Finally, we click on the side that the wall “grows” (where the down right red spot is).

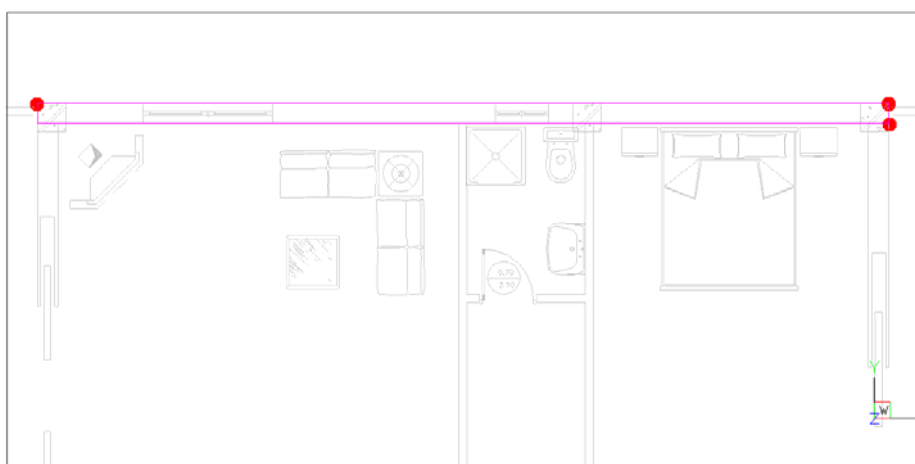
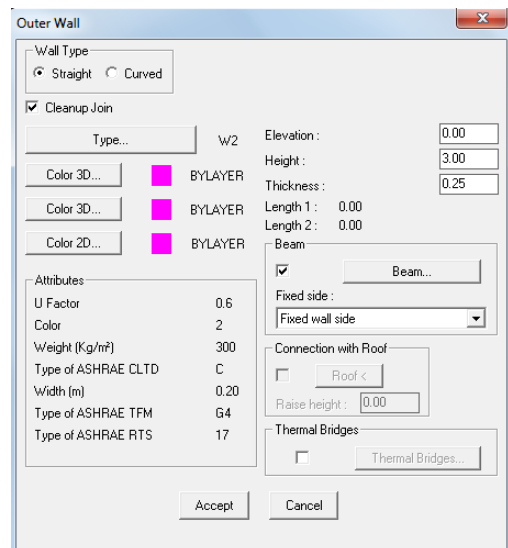

You can enable the “Entity snaps” toolbar (or the “ESNAP” setting) so as to select easily the edges of the wall.

Continuing in the same way, we draw all the walls (inner and outer) of the ground floor.

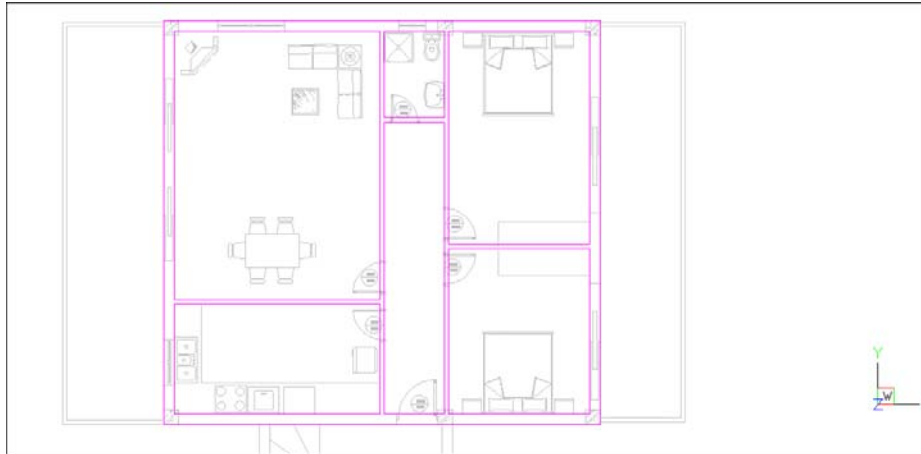

- From AutoBLD, we select Opening > Door and in the properties window, we select the height (2.20 m in our example), the length (1 m), the type of the door etc.

When we finish, we press “Accept” and we design the door:

- First, we select the wall upon which we want to place the door.
- We click on the starting point of the door (where the left red spot is, in the following image)
- We click on the ending point of the door (where the upper right red spot is). As long as you have specified the length of the door, it is not necessary to specify this point exactly. You only need to specify a point near the start towards the side that the second point is located.
- Finally, we click on a point that shows the direction towards which the door will open (where the down right red spot is).

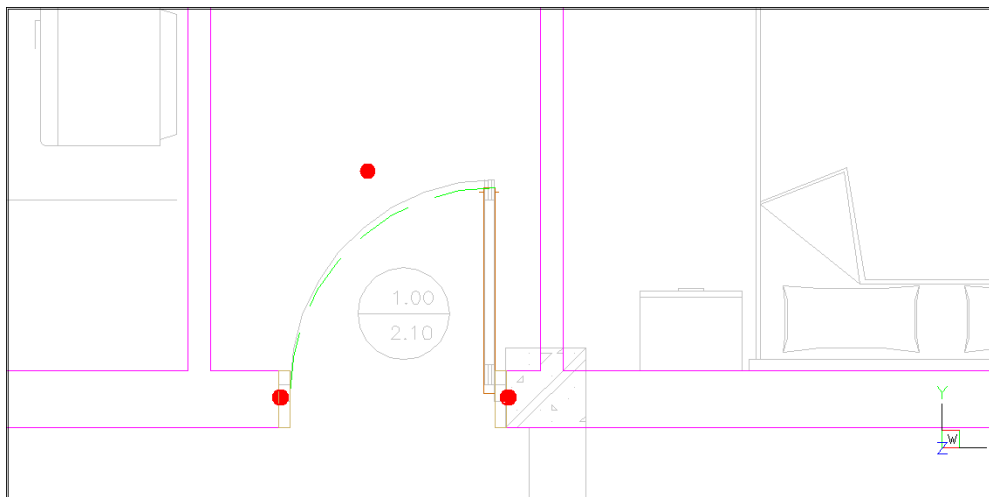
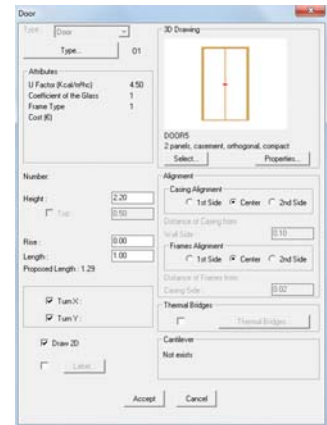

6. From AutoBLD, we select Opening > Window and in the properties window, we select the height (1.20 m in our example), the length (1 m), the rise (0.80 m), the type of the window etc.

When we finish, we press “Accept” and we design the window:

- First, we select the wall upon which we want to place the door.
- We click on the starting point of the window (where the upper red spot is, in the following image)
- We click on the ending point of the window (where the down red spot is). As with the door, as long as you have specified the length of the window, it is not necessary to specify this point exactly. You only need to specify a point near the start towards the side that the second point is located.

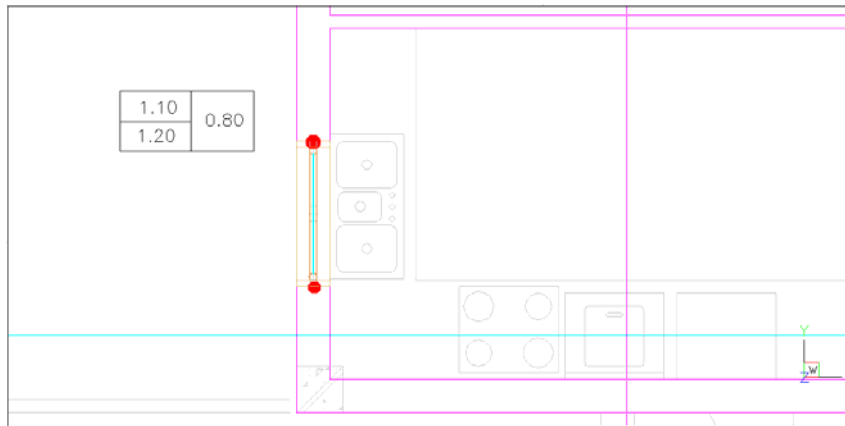
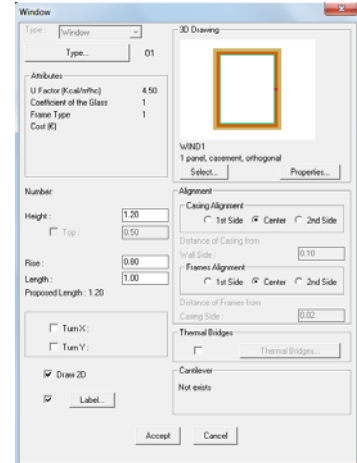

In the following image, we have deactivated the architectural drawing, so as to have a better inspection of the drawing. To do this, go to AutoBLD > Layers management > and uncheck the “XREF” box.

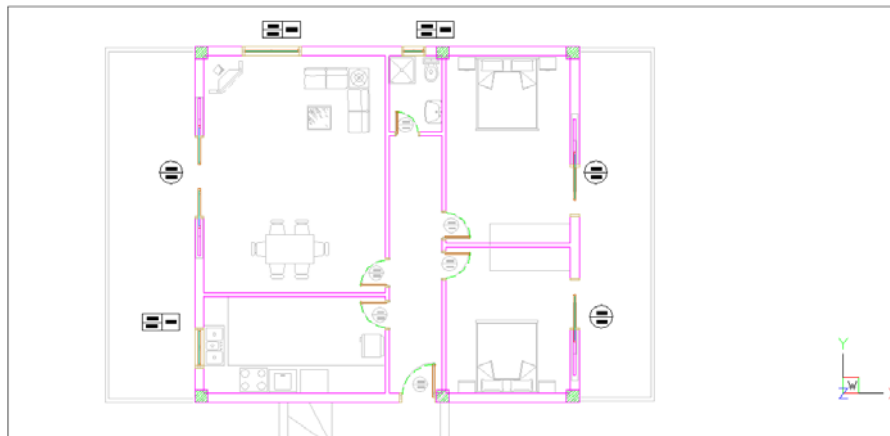

3.10.2. Fire fighting Network design example

1. From Plus menu > we select “Set elevation” and in the command line we type “2.8” meters. In this way, everything that we are going to design will be placed in 2.8 m in z axis in relation to each level.
2. We draw the fire fighting spaces where the sprinklers will be placed from AutoNET > Create fire fighting space. In the window that opens, we give the name “Space 1” for the first room and we define the “Hazard” and the “Minimum density” (5 mm/min in this example).

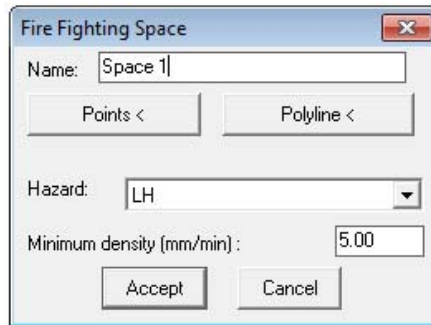

We select to define the space by giving “points”, so we click on the edges of the room as it is shown in the following picture.

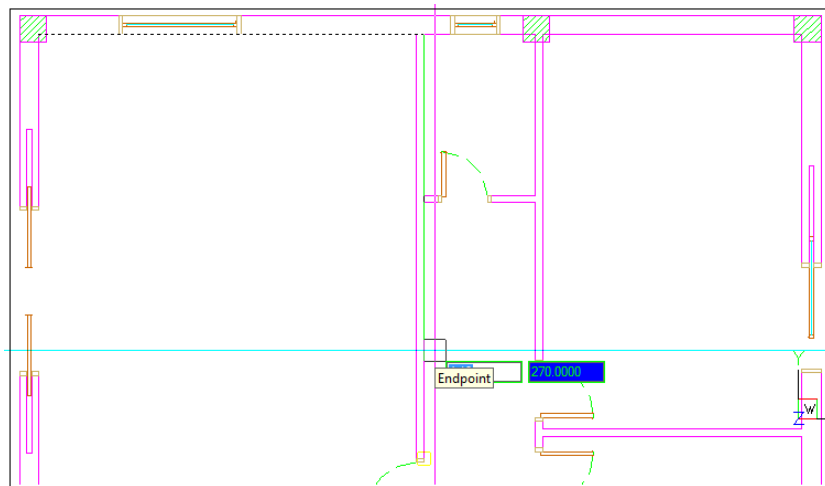

When we finish, we press <ENTER> and in the window that opens again we select “Accept”. The first space has been drawn. Alternatively, we can define the space by selecting a polyline.

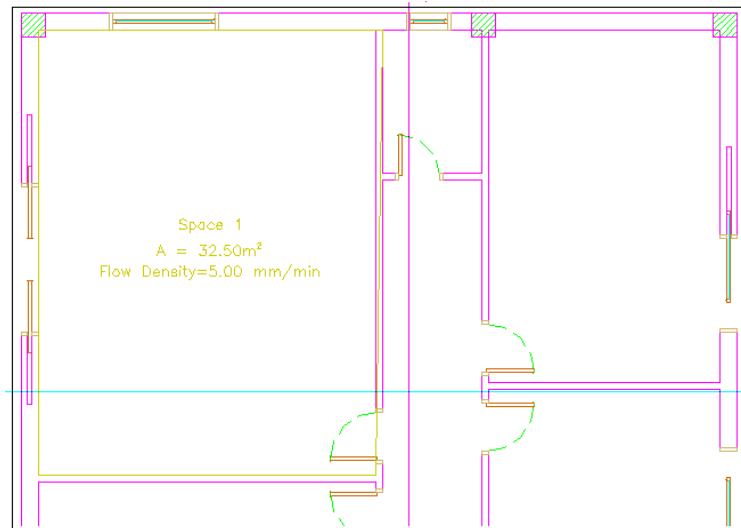

We continue in the same way and draw the rest of the fire fighting spaces and we get the following picture.

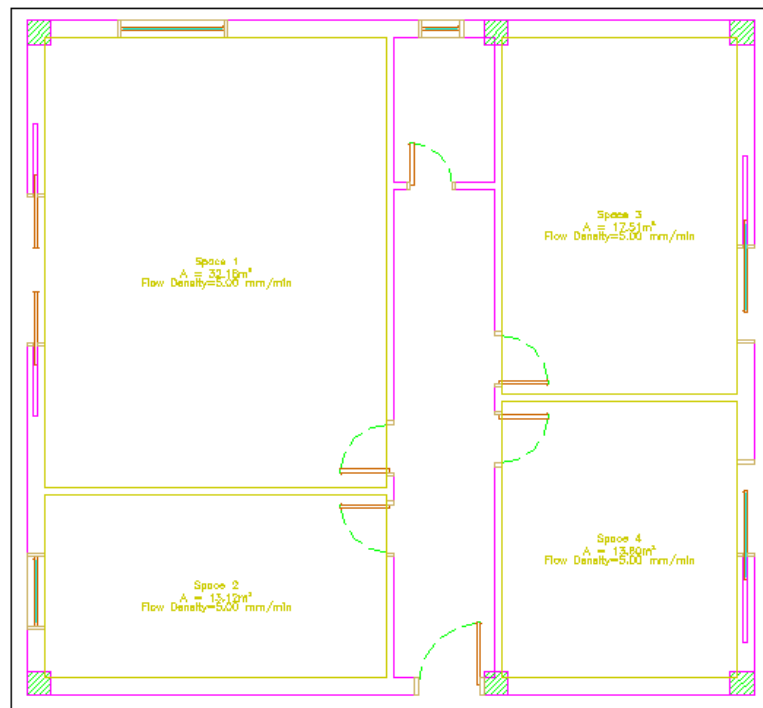

3. The next step is to place the sprinklers on the drawing. In this example we will place them directly in grids using the “Sprinklers Grid” command from the AutoNET menu. In the window that opens:
 - We press on the “Receptor” button and select the “Sprinkler OH roof” type (automatically the “Area of coverage” is filled in).
 - We choose to define the area of the grid by selecting directly the “Fire fighting space” so we press the button and we select the “Space 1” from the drawing.
 - Automatically, the “Rect dimensions” and the “Area” are updated and the program calculates the minimum number of the sprinklers as “3” and proposes to draw 2 rows and 2 columns (in the “Proposed Lines-Columns” area as it is shown in the picture).

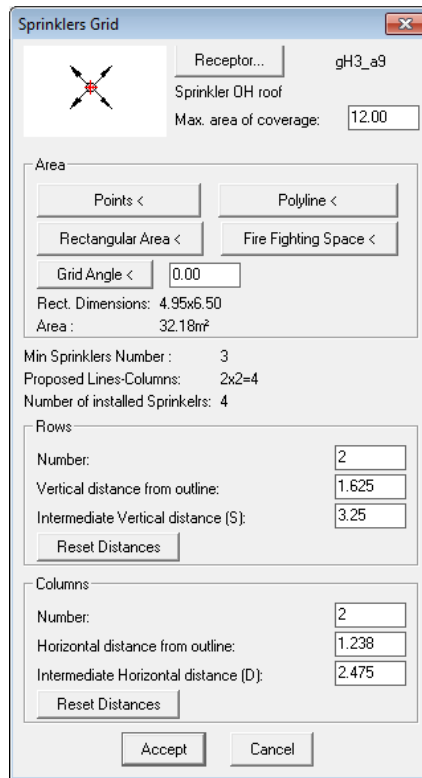

- The next step is to select the number of the rows and the columns of the grid. For this example, we will follow the suggestion of the program and type “2” in both the “Number” cells and we see that automatically the vertical and the intermediate distances of the sprinklers are calculated (we can edit these distances directly if we want).
- Finishing, we press “Accept” and the grid is designed.

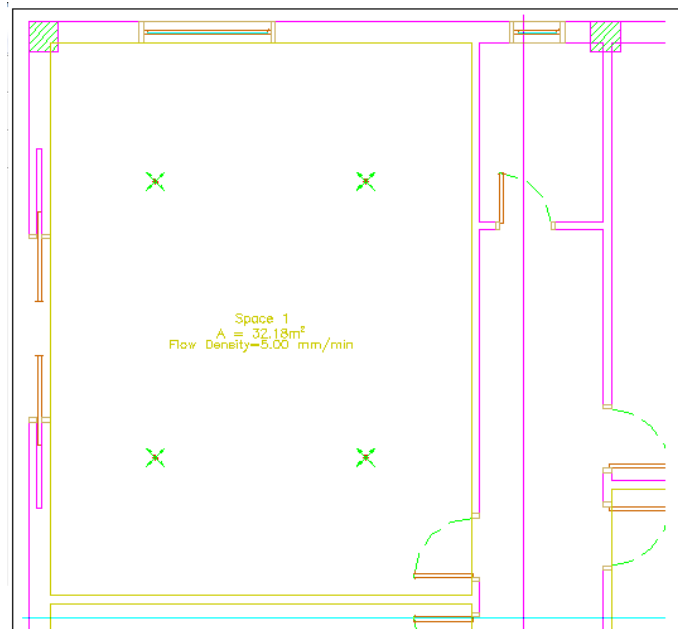

- We repeat the same step until we have designed the grids for all the spaces.

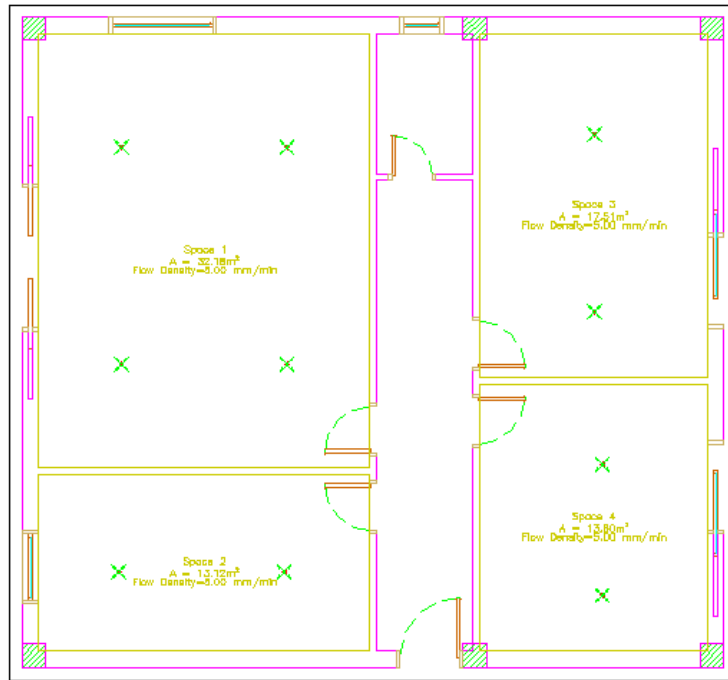

- Next, from AutoNET > we select the “Create area of coverage per sprinkler” command, to check if the sprinklers that we selected can cover the spaces. We simply click on the names of the fire fighting spaces (Space 1, Space 2 etc.) and the program draws the coverage outlines. In our example the outlines are in green color, meaning that our sprinklers can cover the spaces.

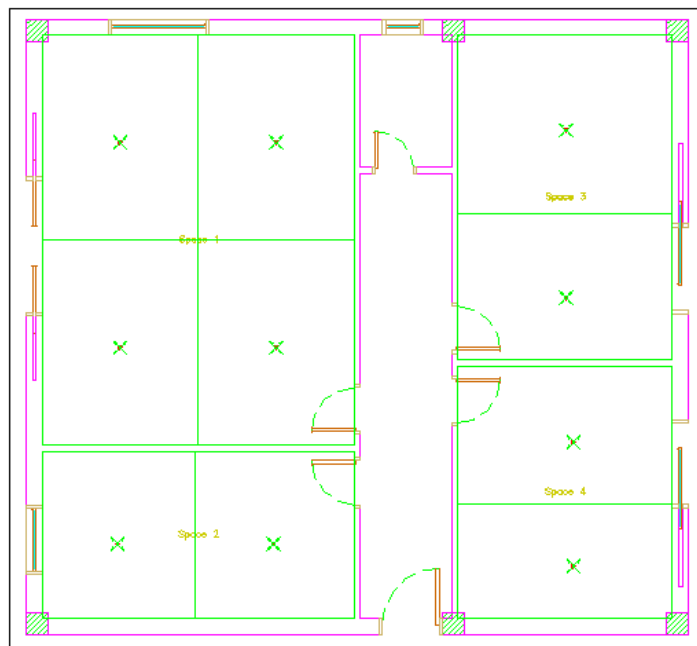

- From AutoNET > we select “Pipe” and start drawing the fire fighting network. If you want, you can draw the pipes in a different elevation by repeating step 1 (in our example, we draw the sprinklers in an elevation of “2.8” m) or draw curved pipes (from AutoNET > “Curved pipe”).

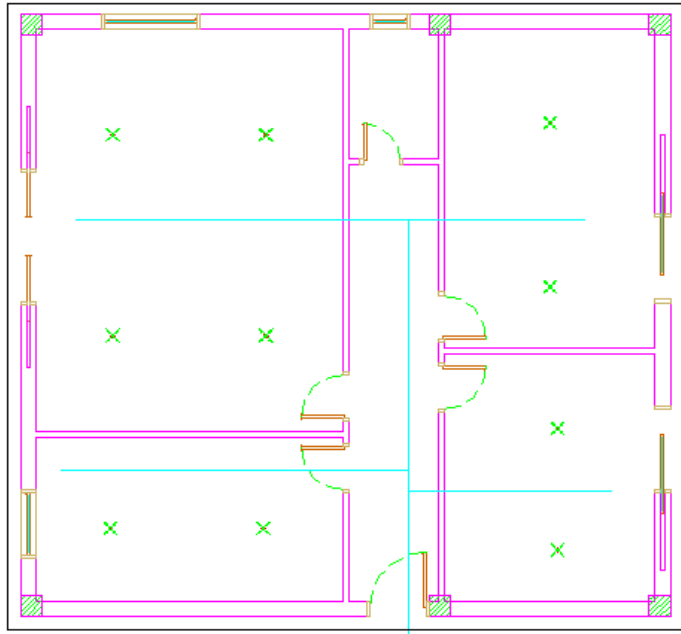

6. The next step is to connect the pipes with the sprinklers and we do this easily by selecting from AutoNET > "Connect receptors to existing pipe" (or from the corresponding symbol  of the toolbar).
- We click on the first receptor
 - We click on the pipe next to it
 - We press ENTER and they are automatically connected.
 - We repeat the step for all the receptors (we can connect more than one receptor to the same pipe each time).

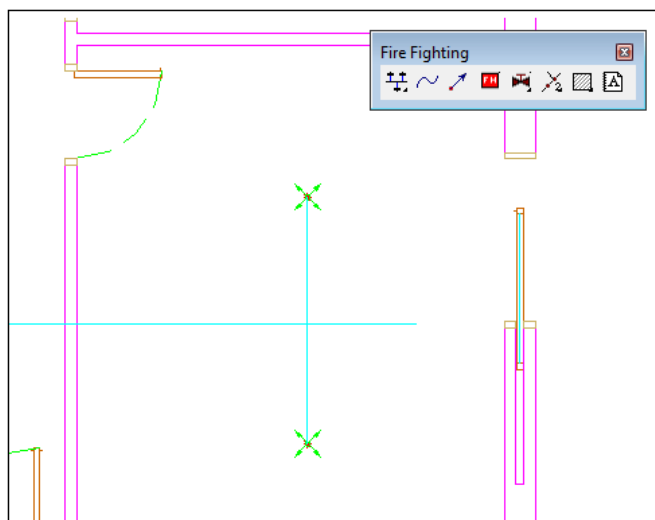

7. If we want to place a vertical pipe that leads to the basement, we select from AutoNET > "Main vertical pipes":
- We click on the location we want to place the vertical pipe (in the command line you can see the "Enter XY location" prompt message).
 - We type the height "-3" which is the starting point of the vertical pipe in this example (the basement elevation).

- We type the height “2.8” which is the ending point of the vertical pipe in this example (from the “Set elevation” command we have set the elevation we are drawing the pipes in the ground floor in “2.8” m) and the vertical pipe is created.

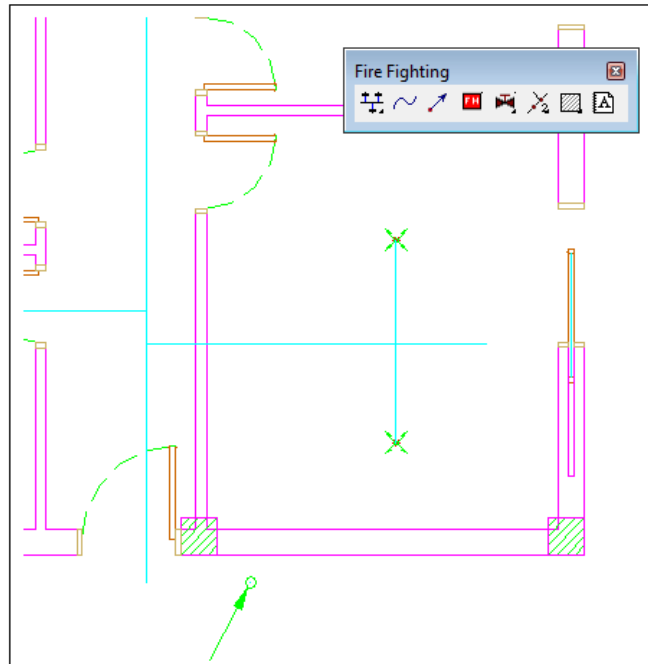

8. From AutoNET > we select “Pipe” and draw a pipe connecting the horizontal to the vertical pipe as it is shown below.

You can use the “Entity snaps” toolbar (it is shown in the picture) to connect precisely the two pipes.

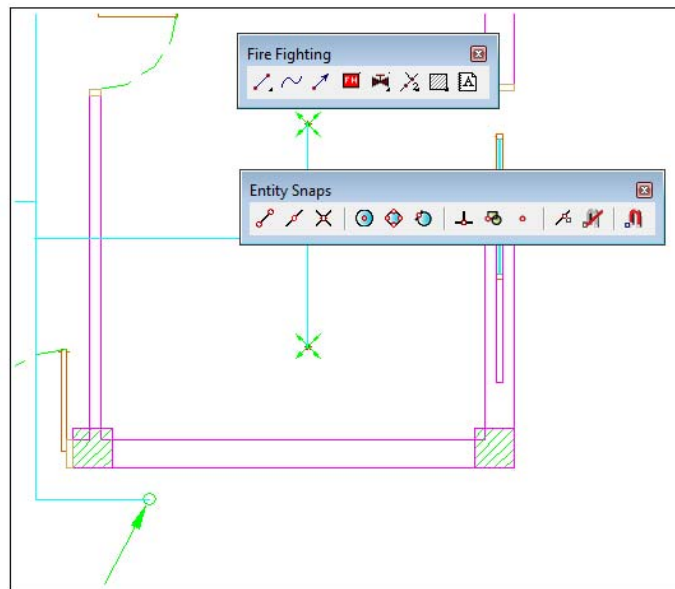

9. We delete the parts of the pipes that we do not want and we get the final network of the ground floor.

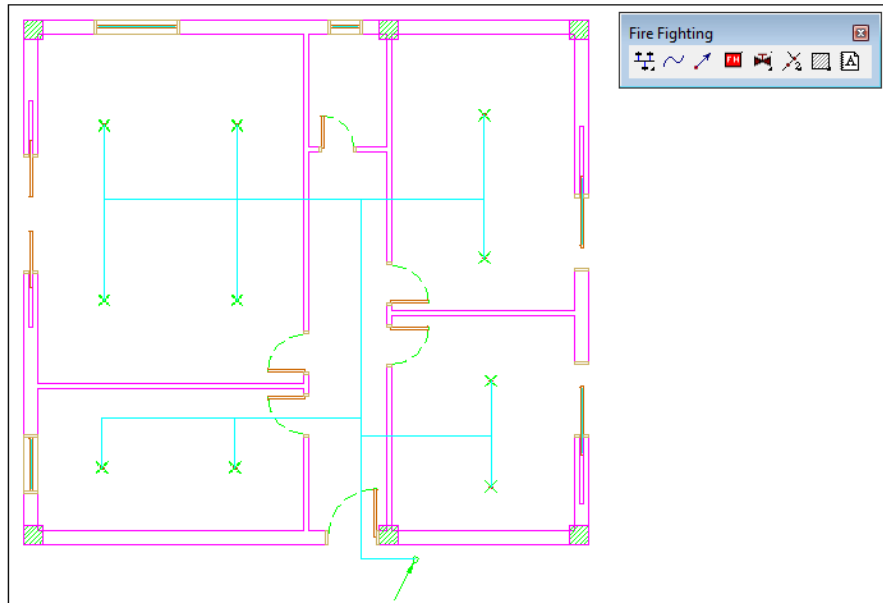

10. By selecting the level of the basement (you can use ▲ ▼ to change levels or double click on the level's name in the left side of the screen) we draw a horizontal pipe starting from the vertical pipe as it is shown below (you can easily connect the horizontal to the vertical duct using the “Perpendicular snap” point).

Finally, from AutoNET > “Supply point”, we set the supply start point symbol (which is for the gauge position). You can easily connect the symbol to the horizontal pipe using the “Endpoint snap” point (highlighted in the following picture).

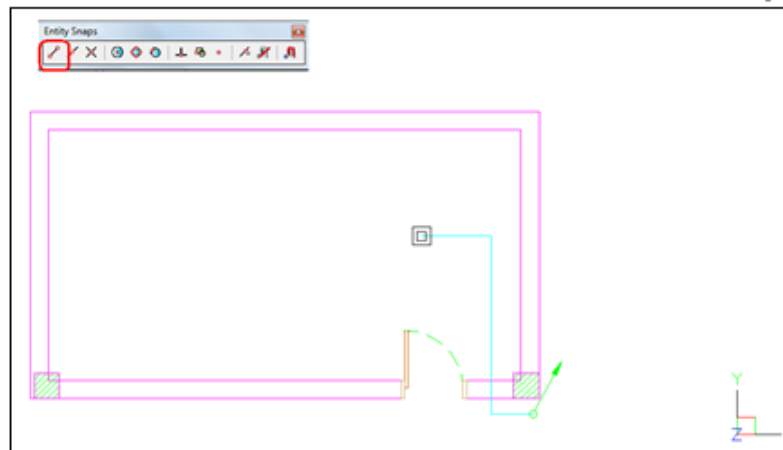

9. We can organize the receptors into groups so as to operate together in case of a fire incident. To do this, we select from AutoNET > “Set group to receptors”, choose the sprinklers we want to work simultaneously and press “Enter”. In the command line the message “Enter group to assign the sprinklers” appears and we type “1”. We continue in the same way to assign the receptors into groups (2, 3 etc.).

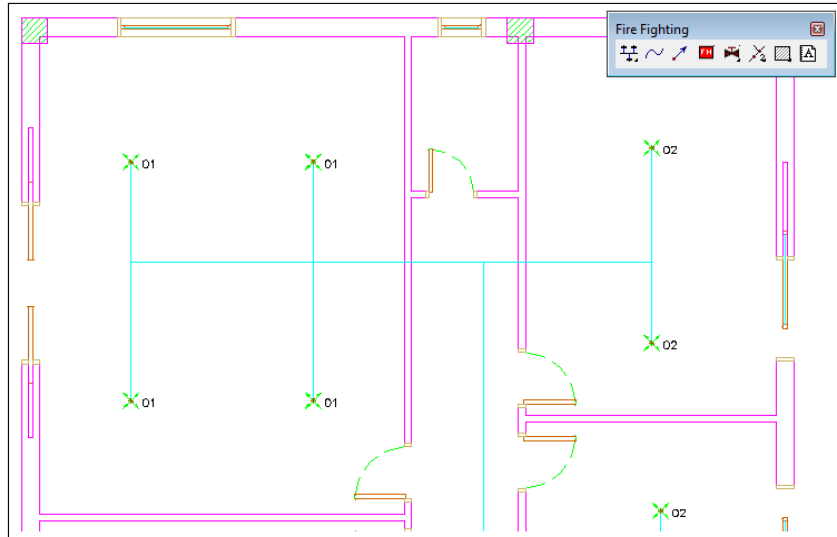

10. Before we proceed to the calculations, we select from AutoNET > “Network recognition”. This is an important step in order to make sure that the network has been drawn correctly. If there are any mistakes, a warning message will appear, otherwise, the network sections are numbered as it is shown below and we can proceed to the calculations.

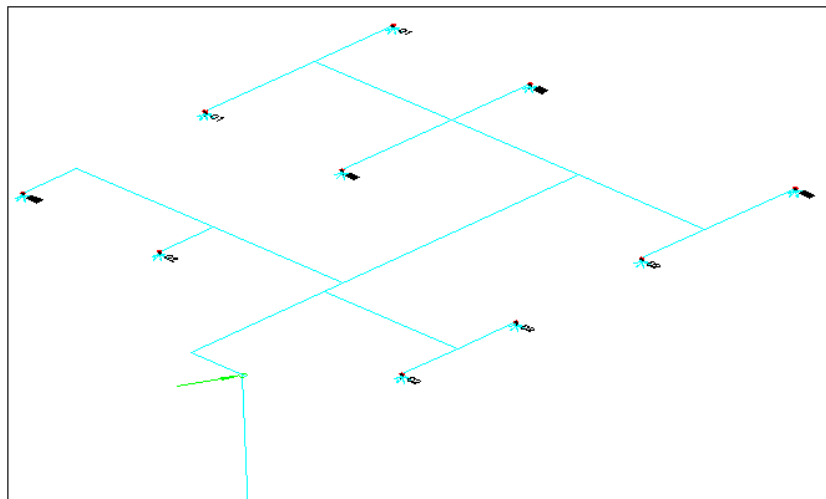

11. From AutoNET > we select “Calculations” and in the window that opens automatically, we select Files > Update from Drawing. From Windows menu we open the Calculation Sheet where the network information has been transferred (detailed information in Chapter 3.7.5).

Fire Fighting - [C:\USERS\ATHINA-CHRISTINA\DESKTOP\MANUAL_EXAMPLE.BLD]

Files Project Data View Calculation Sheet Windows Libraries Help

Calculations

Calculation Sheet

Network Section	Pipe Length (m)	Type of Receptor	Area of coverage per sprinker (m²)	Design density (mm/min)	Receptor Flow (l/min)	Peak Capacity (l/min)	Desired Pipe Size (mm)	Pipe Size (mm)	Max Velocity (m/s)	Water Velocity (m/s)	Type of Fittings	Fittings friction drop (bar)	Pipes friction drop (bar)	Total Friction Loss (bar)	Circuit Polar Angle	Receptors Group	Required discharge pressure (bar)	DP due to Different Height (bar)	Pipe Design Length (m)
1	1.2	3.3			474.25	284.940		1.25"	5	4.692	F-1	0.258	0.264	0.532					
2	2.3	2.4			94.66	94.660		1"	5	2.715	8	0.068	0.097	0.165					
3	3.4	1.0	9	6.159	5.000	47.33	47.330	1"	5	1.358			0.011	0.011		2	0.350		
4	3.5	1.0	9	7.441	5.000	47.33	47.330	1"	5	1.358			0.011	0.011		2	0.350		
5	2.6	0.3			379.60	190.290		1.25"	5	3.133	8	0.085	0.011	0.097					
6	5.7	2.4			94.66	94.660		1"	5	2.715	8	0.068	0.097	0.165					
7	7.8	3.4	9	6.446	5.000	47.33	47.330	1"	5	1.358	5	0.009	0.038	0.047		2	0.350		
8	7.9	0.9	9	6.671	5.000	47.33	47.330	1"	5	1.358			0.010	0.010		2	0.350		
9	6.10	4.1			284.94	189.310		1.25"	5	3.117	8	0.084	0.154	0.238					
10	10.11	2.3			189.31	189.310		1.25"	5	3.117	11	0.084	0.086	0.171					
11	11.12	2.5			94.66	94.660		1"	5	2.715	8	0.068	0.101	0.169					
12	12.13	1.9	9	7.844	5.000	47.33	47.330	1"	5	1.358			0.021	0.021		1	0.350		
13	12.14	1.4	9	8.244	5.000	47.33	47.330	1"	5	1.358			0.016	0.016		1	0.350		
14	11.15	1.9	9	7.844	5.000	47.33	47.330	1"	5	1.358			0.021	0.021		1	0.350		
15	11.16	1.4	9	8.244	5.000	47.33	47.330	1"	5	1.358			0.016	0.016		1	0.350		
16	10.17	2.3			95.63	95.630		1"	5	2.743	8	0.069	0.094	0.164					
17	17.18	1.1	9	7.850	5.000	47.33	47.330	1"	5	1.358			0.012	0.012		2	0.350		
18	17.19	1.5	9	9.660	5.000	48.30	48.300	1"	5	1.385			0.019	0.019		2	0.365		
19																			
20																			
21																			
22																			
23																			
24																			

12. In the calculations part we can also select the fire pump and run an NPSH check from the "Fire pump calculation" window. We fill in the fields in black color in the "Fire pump" and "NPSH" tabs and select a fire pump. Automatically the curve of the pump is shown along with the most favourable and most unfavourable sections (detailed information in Chapter 3.7.6).

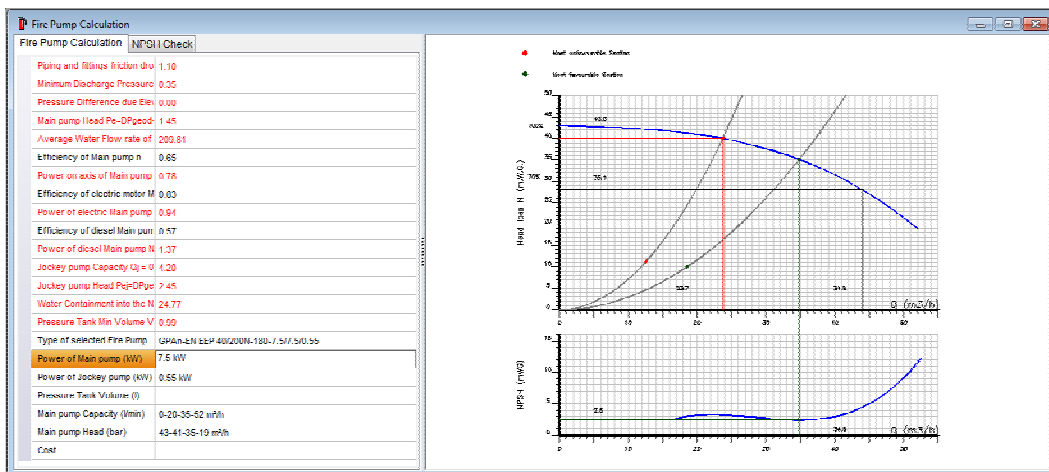

We finish the calculations, we save and close the window and return to FINE FIRE.

13. From AutoNET we select "Update Drawing" and in the opening window we choose which information we want to be show on the screen for the pipes and the receptors.

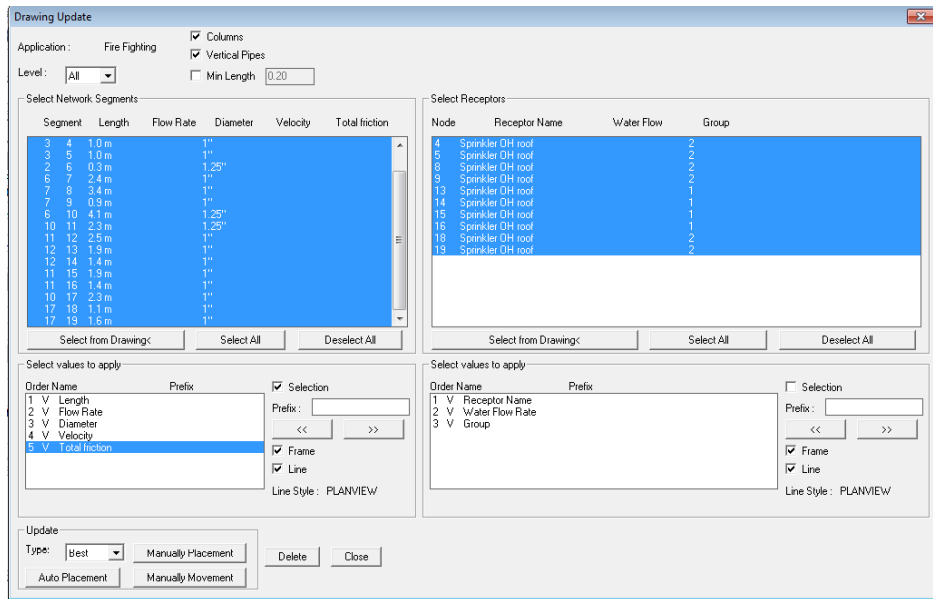

By clicking "Auto Placement", the selected information is shown on each level.

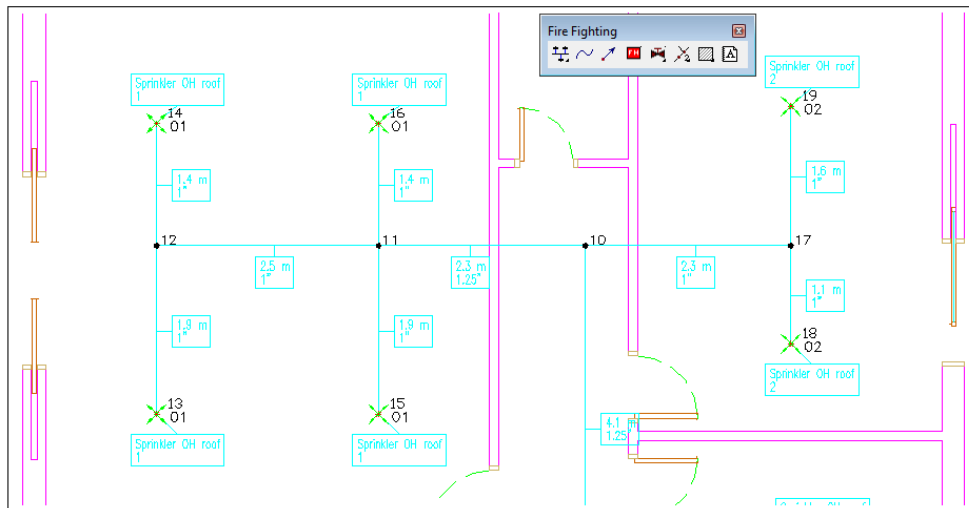

14. From AutoNET we select "Draw most favourable, most unfavourable group and area" and the program show on them on drawing (in green color the most favourable area and group and in red color the most unfavourable) as it is shown in the picture.

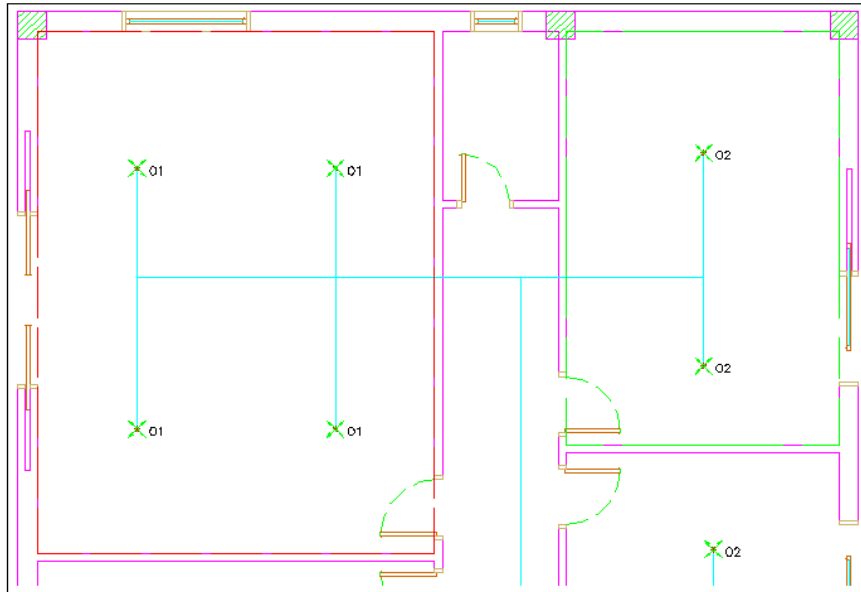

15. Finally from AutoNET we select "Convert single line to 3D" and the program automatically converts the network into 3D in relation to the calculation results.

